

# The Maynooth Newsletter

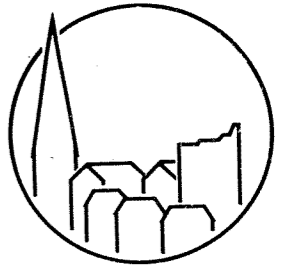

ISSUE 196

NOVEMBER 1993

PRICE 50p

**From Maynooth to Manhattan**

*Ref. Only. Do NOT REMOVE*

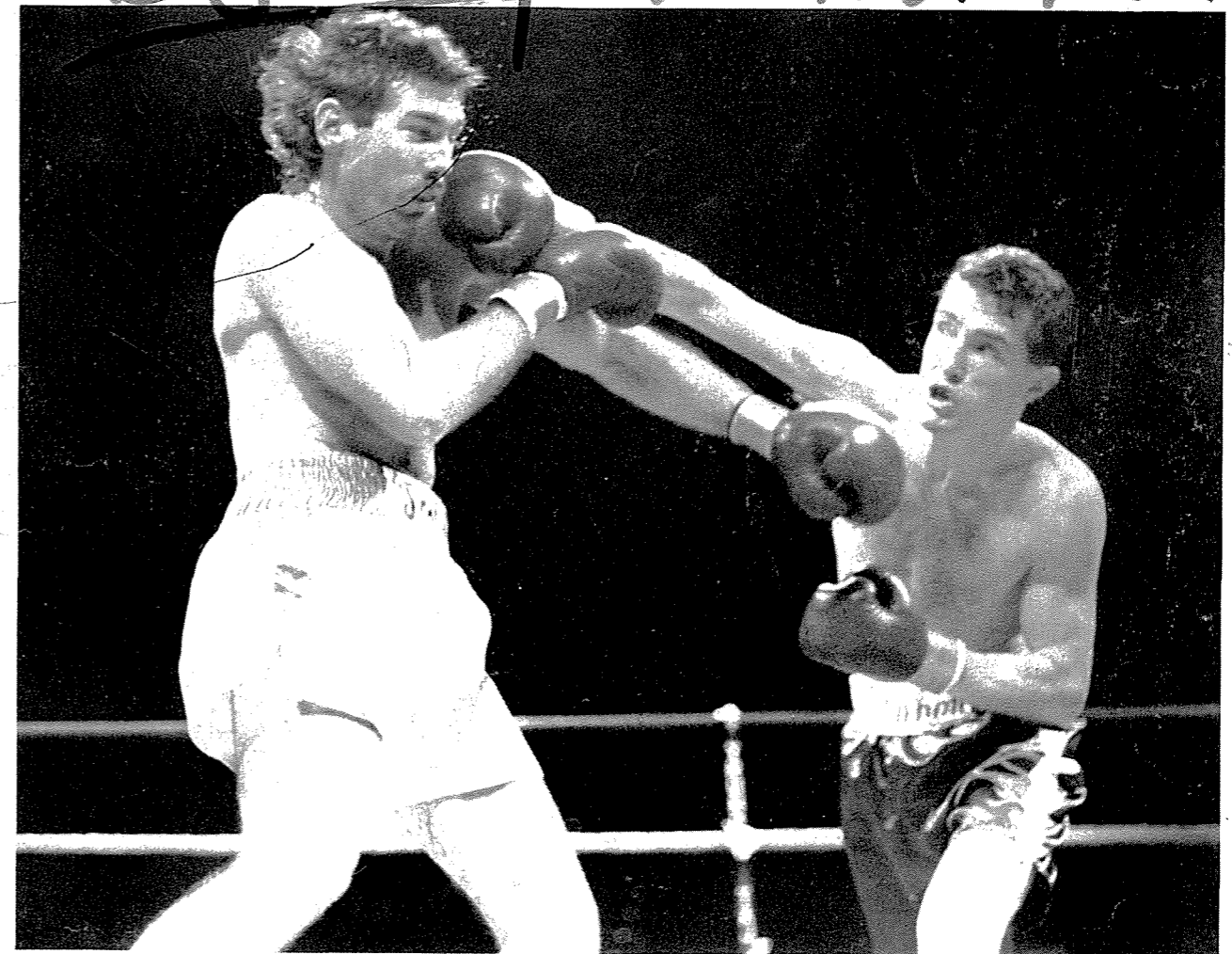

Jimmy McMahon in action against Mantel Phillips in Atlantic City, Jay Mahal Casino, in a professional bout, which he won in the third round by a knock out.

Tidy Town Results . . . Page 6 • Features . . . Page 28  
Sports News . . . Page 42



WITH



THE CARDINAL PRESS



YOU



CAN

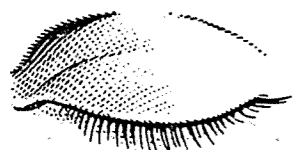

COLLECT



JOBS

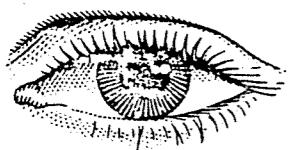

THIS



FAST.

Contact

## The Cardinal Press

Dunboyne Road, Maynooth, Co. Kildare.  
Telephone: 01 - 628 6695 • Fax: 01 - 628 6440

- FULL COLOUR BROCHURES
- NEWSLETTERS
- QUALITY WEDDING STATIONERY
- CONTINUOUS STATIONERY
- COLOUR COPYING
- OFFICE STATIONERY & FURNITURE
- TYPESETTING (LASER & IBM)
- GENERAL PRINTING
- INVOICES
- NCR SETS
- STATEMENTS
- LETTERHEADS
- BUSINESS CARDS
- TICKETS
- POSTERS
- LASER PRINTING
- BOOK RESTORATION & THESIS BINDING



**Put Your Problem on our plate !**

For all your Catering requirements  
contact us at our new address



**Peter O'Brien Catering Co. Ltd.**

Monread Commercial Park, Naas, Co. Kildare.

Tel. 045 - 74288 • Fax. 045 - 74290

FULL RANGE OF TABLEWARE FOR HIRE

## LABOUR ADVICE SERVICE

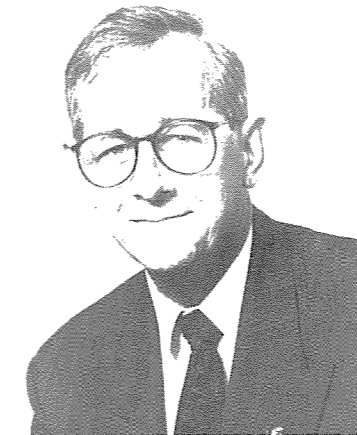

**EMMET STAGG, T.D.**

Every Saturday at 4 p.m.

in

Caulfield's Private Meeting Room



**JOHN MCGINLEY M.C.C.**

Every Thursday at 8 p.m.

in

Caulfield's Private Meeting Room

**LABOUR IS WORKING FOR YOU**

## Community Council Notes

### COMMUNITY COUNCIL NOTES

The next Community Council meeting will be held on November 8th at 8p.m. in the Post Primary School. It is hoped that many more Community Councillors will attend than attended the last meeting in September.

Residents Associations are entitled to send a representative for each fifty houses. Other organizations such as clubs and societies are also entitled to send representatives.

Only by a comprehensive representation from the entire community is it possible to have the views of all known.

### BORD FAILTE 1993 TIDY TOWNS COMPETITION

#### SYNOPSIS OF JUDGES' COMMENTS

##### Effort:

Max. 1991 1992 1993  
45 26 27 28

The town of Maynooth has made a number of improvements in presenting the town this year - well done.

There are good individual efforts being made, but Maynooth has a long way to go.

Main Street was fairly well presented, particular attention needs to be paid to areas off the Main Street.

##### Maynooth Committee comments:

The good solid work of the S.E.S. workers was seen by the judges.

##### Tidiness:

Max. 1991 1992 1993  
40 10 10 13

On adjudication day Maynooth was looking well, more litter-free than last year. The town still needs more litter bins, pockets of litter were evident around the town. The area around the University and Castle was very tidy this year. Parson Street was also mentioned as being very tidy.

##### Maynooth Committee comments:

At last people are using the litter bins but we need more and this will be a priority for the coming year.

##### Presentation of Buildings:

Max. 1991 1992 1993  
40 30 31 31

There are many fine examples of traditional shop fronts in Maynooth which are a credit to the Business Community. They include Katies Flowers, Frank Regans, Hula Bou, Denis Enright, O'Neills, Leinster Arms, Mullins and Henry Opticians, The University Campus, Vincent de Paul and St. Catherine's Hostels. The Church and its grounds were also well presented.

##### Maynooth Committee comments:

This category has been very good for the last few years and perhaps there may be another mark or two to collect. There are some buildings or their environs that need to be improved. We will be making strong representations to these business owners.

##### Presentation of Natural Amenities:

Max. 1991 1992 1993  
50 17 17 17

Maynooth has a number of fine amenity areas including The Canal area, Carton Amenity Walk, Maynooth Castle, University and Pitch and Putt area.

Areas that could be improved are Carton Amenity Walk, Playground area, Canal area, and area around Public Toilets.

##### Maynooth Committee comments:

This section is going to be very difficult to improve on until the Toilet block is gone and the Playground is sorted out. We would like to thank our Canal Group for all the hard work in improving this important amenity in Maynooth.

##### Appearance of Approach Roads:

Max. 1991 1992 1993  
45 11 12 13

The approach road from Leixlip - the grass verges on either side needed cutting, the approach from Kilcock was neat with trees planted, grass cut etc. Adjudicator suggests flower beds. Flower beds could also be planted on the approach road from Dunboyne to tidy up this area.

##### Maynooth Committee comments:

This is an area we will be concentrating on with the co-operation of Kildare County Council.

##### Presentation of Residential Areas:

Max. 1991 1992 1993  
30 18 19 20

The majority of the residential areas are well presented. One individual effort noted this year was the house and gardens opposite Maynooth Castle. Good mentions for Newtown Court, Cluain Aoibhinn, the Park opposite Beaufield, Beaufield itself, Manor Court, Rail Park, Greenfield Estate, Kingsbry and Carton Court.

##### Maynooth Committee comments:

An excellent performance keeping up the tremendous work being undertaken by the residents and residents' groups in their areas. Well done also to the Murphy family for the hard work over keeping their garden and surrounds so neat and tidy opposite Maynooth Castle.

##### Maynooth Committee comments:

Overall, the improvement in Maynooth continues. We thank anyone who helped during the past year. Again, if anyone would like to help Maynooth Tidy Towns Committee can be contacted through the Maynooth Community Council Office.

*Richard Farrell, Secretary*

## HEATING SERVICES

OIL FIRED BOILER BURNER SERVICE

HEATING SYSTEMS MAINTENANCE

HEATING EFFICIENCY TESTING

You could be wasting over 50% of your oil  
24 HOUR SERVICE - 7 DAYS A WEEK.

**Dermot Bradley 49 Cluain Aoibhinn Maynooth Phone: 6285387**

## DR. LINDA M. FINLEY

CHIROPRACTOR

97 CARTON COURT  
MAYNOOTH  
CO. KILDARE.

TEL : (01) 6285962



4 BELGRAVE ROAD  
RATHMINES  
DUBLIN 6.

TEL : (01) 970174

### ALL HOURS BY APPOINTMENT ONLY

Tues	10a.m. - 1p.m.	Mon & Thurs
	5p.m. - 8p.m.	10.15a.m. - 12.30p.m.
Wed	10a.m. - 12.00 & 5p.m. - 8p.m.	4.00p.m. - 8.00p.m.
Fri	10a.m. - 12.00 & 5p.m. - 8p.m.	

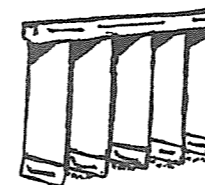

**BLINDS**  
**DENIS MALONE**

**BLINDMAKERS LIMITED | COOLDRINAGH, LEIXLIP.**

**PHONE : 6244943 ANYTIME**

**YOUR LOCAL BLIND MAKER • FACTORY PRICES**

**• OVER 20 YEARS OF EXPERIENCE •**

**WE MANUFACTURE TOP QUALITY, ROLLER, VENETIAN AND VERTICAL BLINDS.**

**FULL REPAIR SERVICES TO ALL TYPES**

**HAVE YOUR OLD ROLLER BLIND REVERSED**

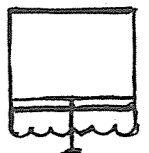

**PLANNING AND DEVELOPMENT NOTES**

Our new Social Employment Scheme has been sanctioned by FAS and will be up and running from 25th October. As finance is required to help fund the scheme we will be holding several fund-raising activities throughout the year starting with a Christmas Raffle.

We hope to repeat our very successful Race Night and even a golf classic may be in the offing.

*Billy Mulhern* B.Comm. A.C.A.  
**J.W. MULHERN & CO.**  
 Chartered Accountants  
 13/14 South Main Street  
 Naas, Co. Kildare.

Tel. 01 - 628 6751 • 045 - 66535  
 Fax. 045 - 66535 • 045 - 66521

Fees Discussed Before any Assignment

MANY OF TODAY'S ILLNESSES & DISEASES  
 ARE DUE TO STRESS AND TENSION

**REFLEXOLOGY**

A NATURAL AND DRUGLESS  
 WAY TO REDUCING STRESS  
 AND TENSION IN THE BODY



FOR APPOINTMENT CONTACT  
 ELLEN SMITH M.S.R.I. PRACTITIONER  
 PHONE: 628 6466

**BARRYS NEWSAGENTS**

Newsagents - Tobacconist - Confectioners  
 Telephone: 628 5730

Selection of Lighters • Stationery  
 Parker Pens • Gift Ware  
 Cooked Meats a Speciality

CIE Commuter Tickets  
 Weekly, Monthly & Students  
 Monthly Family One Day

Opening Hours: 6 a.m. - 10 p.m. Mon. - Sat.  
 Sun. 6 a.m. - 9.30 p.m.

**BAND BULLETIN**

**Garda Concert**

The Lions' Club Concert in the Aula Maxima last month was, musically at least, a great success. Unfortunately the Hall was a little more than half full but those who turned up were treated to a wonderful show by the Garda Band who included the full range of music from Céilí to Glen Miller to Neil Diamond while the audience played their part by participating in a Cute Cuban Cha Cha number which went down very well indeed. Our Band opened the second half of the programme and we were delighted with the reception we received. While "not at the races" as far as the Garda Band were concerned our young boys and girls (resplendent in their bow ties) turned in an excellent performance and they enjoyed the experience of being on the same programme with the Garda Band. Hopefully we can build on this experience for our future performances.

**Band Mass**

Our Annual Mass for Deceased Members will be offered at 11 o'clock on Sunday 7th November next. This is our most important engagement of the year and every band member makes a special effort to ensure that they are with the Band for this Mass because we remember all our fellow members who have gone before us, people who have dedicated a great part of their lives to helping the Band and making sure that there will always be a Band in Maynooth. These men had a great sense of pride in St. Mary's Band and it is that thought which will be uppermost in our minds on November 7th when we hope we will be joined by the relatives and friends of these deceased members.

**Race Night**

That Hardy Annual Fundraiser our RACE NIGHT will be held in the GAA Club, Moyglare Road on Friday 19th November with the horses lining up for the first race at 8.30. This has been our most successful fundraiser of the year in the past and we hope this year will be no exception. It is a very enjoyable night where you can have a flutter on the horse of your choice without losing your shirt and then have a drink to celebrate or console, whichever is appropriate, all in a good cause. If you want to go a little further and sponsor a horse for £10 or a race for £50 you can contact Michael Dempsey at 6286948 or Paddy Boyd at 6286468 as soon as possible. We hope to see you all there on Friday 19th for a great night's entertainment.

That's about all the news for this month, see you all here again in December for the Christmas notes.

**ACTIVE AGE GROUP**

Our monthly meeting takes place on the 1st Monday of each month in the Health Centre, The Harbour, Maynooth at 8.00 pm. We always welcome new members.

Last month we had an enjoyable day in Athlone. We hope to arrange more visits to the theatre during the coming months, and our weekly walk continues.

We may change the time of our meetings during the winter to facilitate our members. This will be discussed at our next meeting.

W. Geoghegan P. R. O.

**MAYNOOTH CURTAINS**

Main Street, Maynooth

Tel. (01) 6286888

*Curtains - Blinds - Rails*

*All made to measure and fitted*

See our new range of 1993 fabrics and designs

ALL ESTIMATING FREE

Mon - Tues : 9.30 - 6pm  
 Wed : 9.30 - 1pm  
 Thurs/Fri/Sat : 9.30 - 6pm

**MAYNOOTH CREDIT UNION LIMITED**

*Credit Union House, The Harbour, Maynooth, Co Kildare Tel: 6286741*



CHRISTMAS



LOANS



HOLIDAYS



HOME IMPROVEMENTS

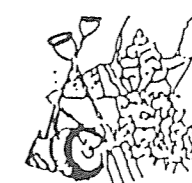

EDUCATION

**CAN YOU AFFORD NOT TO BE A MEMBER?**

**Opening Hours: Thurs/Fri 7-8.30 p.m., Sat. 10-12.30 p.m.**

## Clubs, Organisations & Societies

### CELBRIDGE BEREAVEMENT GROUP

A number of men and women from the parish have set up a Bereavement Support Service which is based in the St. Eustace Centre, Main Street. The aim of this service is to offer support and a listening ear to bereaved people, whether the bereavement is recent or happened a long time ago. It may help just to know that there is someone you can speak to in confidence.

For further information, please feel welcome to call to the Eustace Centre on Wednesdays 10.30 a.m. - 12 noon.

### CELBRIDGE FRIENDSHIP AND SUPPORT GROUP FOR SEPARATED PEOPLE

MEETING EVERY THURSDAY EVENING AT 8.15p.m. in St. Eustace Centre in Main Street, Celbridge.

The aims of the Group are to offer friendship and support to each other, to arrange social events for ourselves and to have some occasions where our children can be together and feel accepted.

For further information contact:  
6288210 or 6288758 or 6288019.

### CHURCH OF IRELAND NOTES

**Church Christmas Bazaar** on Saturday 27th. November 1993 At "Mariaville" Maynooth, from 10a.m. to 4.00p.m. Stalls: Cakes/Jams, Bric-a-Brac, Plants, Tea/Coffee/Soup In aid of Church Restoration Fund. Admission £1.00

### CIC NOTES

**Question:** I retired recently and would like to become involved in voluntary work. Could you suggest how I might go about this?

**Answer:** The first thing you should do is ask yourself the following questions:

- How much time do I have to give?
- Do I want to work with the old or the young?
- Would I mind doing this work at night?
- Do I want to make use of the skills I have or would I like to become involved in something new?
- Am I prepared to travel outside my own neighbourhood or would I prefer to work close to home?

The National Social Service Board have just published a very helpful booklet on volunteering - 'Now's The Time'. This booklet has lots of ideas and suggestions about volunteering.

Copies of this booklet are available free of charge from our Centre or from any of the Citizens Information Centres around the country. CICs could not operate without the many thousands of dedicated volunteers who give so generously of their time.

We are always on the look out for new volunteers and who knows you might even join us in this very interesting work. You will find us listed in the Golden Pages under Citizens Information Centres.

Free copies of "Entitlements for the Elderly" and "Volunteering opportunities for older people" may be collected in our Main Street office.

**Opening Hours (6285477)**  
Main Street (Above Kehoes)  
Mon-Fri 9.30am-1pm and 2pm-4.30pm.

**Library**  
Tues 2.30pm-4.30pm

**College**  
Tues 11am-2pm

**Dunboyne Community Centre**  
Mon 10.30am-12.30pm  
Thurs 2.30pm-4.30pm

### CREDIT UNION NOTES

**Thanks all Round!**

It was wonderful to find out how influential these Notes in the *Maynooth Newsletter* can be. Our call for volunteers last month did not fall on deaf ears. It wouldn't be fair to name names, but there will be new faces appearing behind the desk in our office.

We want all new volunteers to know that we are absolutely delighted with your generous response. Your time and energy will go into a very worthwhile community organisation. I have to be honest, though, and admit that most of the new tellers volunteered through direct contact with our members who were carrying out a survey at the offices between 7th and 9th October.

### Researching New Services

The recent survey on improvements was carried out because our Board of Directors wants to develop the Credit Union to meet the members' needs. About 170 members responded to questions about opening hours and their interest in availing of services like VHI Group Scheme, Budget Planning or Home/Contents Insurance through the Credit Union.

First impressions of the responses suggest a high level of satisfaction with the service provided in our branch. It is very reassuring for our volunteers to know this and will encourage us to make an even better effort. We will pay close attention to the negative comments as well, and do whatever we can to benefit from that feedback too.

### Our Annual General Meeting

The results of the survey will be available for our AGM which will take place on **Tuesday, 16th November** in the **Boys' National School** at 8 p.m. Last year's AGM (my first), impressed me for several reasons.

continued



## A TASTE OF ITALY

has come to Maynooth

Wine Licence  
Party Bookings Taken  
Phone (01) 6289660

IN

# "DONATELLO'S"

Ristorante/Pizzeria  
(nestling in the Town Centre Mall)

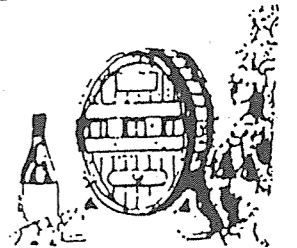

Try a tempting pizza cooked to perfection by Antonio  
Proprietor/Chef: 4th generation pizzaiolo  
or

choose from our extensive authentic Italian Cuisine  
When it comes to dessert you must try one of our Italian home-made icecreams  
made from a one hundred year old family recipe - and all at a price you can afford

Open Daily: Set Lunch menu 12 - 3 pm Evenings: Open 6 pm - midnight



BOOK NOW FOR YOUR CHRISTMAS PARTY



Have you ever wondered what it takes  
to be a good Child Care worker ?

# We know !



Kids Kottage.

LIGA

Highly Commended  
Liga Creche of the Year 1993  
Leinster Area

DAY NURSERIES

KIDS KOTTAGE DAY NURSERIES LTD., 287 OLD GREENFIELD, MAYNOOTH, CO. KILDARE.

CONTACT: GER SCANLON TELEPHONE 6285 633

LIGA

Highly Commended  
Liga Creche of the Year 1993  
Leinster Area

## Clubs, Organisations & Societies

Firstly, the meeting started quite promptly. Then the Agenda was dealt with in a business-like manner - all the Board Members had done their homework and their professionalism was very evident. It was really interesting to learn from the Loans Committee Report how the members use their savings. It was also the first time I appreciated how much responsibility and hard work had been involved in the Board's decision to computerise our operations.

And after the business, there was tea and chat before going home for an early night - or leaving for an adjournment to other premises in the village, perhaps? Anyway, it's an event for members' diaries and they will all be welcome. Next month's Notes will include a brief report on our deliberations and the results of our survey.

*Emer McDermott, P.R.O.*

### Maynooth Secretarial Services

Maynooth Community Council

Main Street, Maynooth (Above Kehoe's)  
Phone: 628 5922 • Fax: 628 5079

Word Processing • Typing • Photocopying  
Minutes • Letters • Theses etc.  
*Service Confidential*

Contact: 628 5922  
10 a.m. - 4 p.m. Monday - Friday

### THE ATTIC

SWOP SHOP PLUS  
Mill Street, Maynooth  
Phone: 628 9713

Day • Evening • Casual Wear • Shoes  
Handbags • Jewellery  
Beautiful Bridal Gowns at realistic prices

After 6.00 p.m. viewing can be arranged by phone

Now accepting Autumn/Winter garments  
Can collect from your home by arrangement

Open 10 - 6 Monday - Saturday

### GLOR NA nGAEL - MAIGH NUAD

Tá comórtas an bliain seo thosnaithe cheana féin le ranganna Gaeilge i halla socialta an Chumann Luth Chleas Gael, Bóthar Mhá gCláir gach oíche Dé Máirt ag a h-ocht a chloig. Má tá spéis ag aon duine a bheith páirteach in obair Glór na nGael i Maigh Nuad beidh fáilte romhat chuig chruinneadh tar éis na ranganna ar an Máirt.

Tuesday Nights £1.00 - 8 p.m. G.A.A. Social Centre. Ciorcal Comhrá.

This year events have already begun with a 'Ciorcal Comhra' or 'Conversational Circle' for beginners of Irish. The 'ciorcal' meets every Tuesday night at 8.00 p.m. in the G.A.A. Social Centre, Moyglare Road, Maynooth. These classes for beginners are taught by Máire Ní Scanáil agus tá táille £1.00 don rang. People in the Maynooth area who have 'Gaeilge' or 'beagán Gaeilge' (a little Irish) should come along to the meeting after the class to discuss ways in which we can best promote the Irish language and culture in Maynooth. Beidh fíor fáilte roimh chách.

Beir bua agus beannacht,

*Colm O Cearúil*  
*Runaí Glór na nGael*  
*Maigh Nuad*

### IRISH WILDBIRD CONSERVANCY

#### Liffey Valley Branch

The IWC has a nationwide series of branches to cater for its approx 4,500 members, of which about 140 live in the Liffey Valley area. This branch covers parts of Dublin West and Kildare.

Every year the Liffey Valley Branch holds about 18-20 events which are open to the general public, with non IWC members being particularly welcome. With the exception of coach trips all the events are free. Activities are usually organised for September to November and from January to June, with a break in December and in July and August.

We usually organise an evening activity on the 3rd Tuesday of each month. These consist of a slide show and talk on birds or other natural history/conservation subjects or during the brighter evenings a short walk to see a local bird habitat. On the Saturday following the evening meeting we normally organise a day outing where we go further afield. We also organise about 2 coach trips per year. In the past we have had very successful coach trips to among other places the Shannon Callows for corncakes, Lough Neagh for waterfowl, and the Wexford Slobs for geese.

We also take an interest in local conservation issues, carry out surveys on bird populations for national and international organisations, and act as temporary wardens at breeding sites for endangered species. All our activities are carried out on an

continued

Support Your Local Coal Merchant

## BILLY McCRORY



- Premium Polish, Texan and Economy Coals and Slack
- Anthracite and Extracite
- Grade 'A' Anthracite
- Smokeless Wonder Coal
- Coalite and Coal Briquettes



CALL US ANYTIME  
MAYNOOTH 6286859 DUNBOYNE 8251202  
24 Hour Answering Service  
No Delivery Charge

YOU HAVE TRIED ALL THE REST NOW TRY THE BEST

ALL SMOKELESS FUEL AVAILABLE

## JOE MOORE

STRAFFAN ROAD, MAYNOOTH

TEL : 6285586



TELEVISION &  
VIDEO REPAIRS

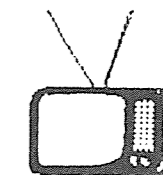

MON - SAT

ALL REPAIRS GUARANTEED  
SAME DAY SERVICE  
FREE ESTIMATES

9 A.M. - 9 P.M.

SATELLITE DISHES ALSO AVAILABLE - PHONE FOR DETAILS  
NEW AND SECOND-HAND TV AND VIDEO SETS FULLY GUARANTEED

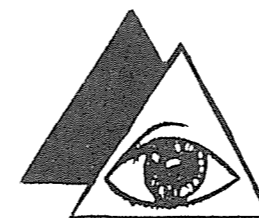

MULLINS & HENRY F.A.O.I.  
OPTOMETRISTS

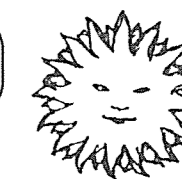

YOU ONLY HAVE ONE PAIR OF EYES  
...Take Care Of Them

We provide : \* Full Eye Examination \*  
\* Glaucoma Testing \* Driving Tests \*  
\* Colour Vision Tests \* Contact Lenses\*

\* Same Day Service \* Fashion Frames \*  
\* Budget Frames \* Laboratory on Site \*  
\* 1000 Frames on Display \*

MEDICAL CARD HOLDERS & P.R.S.I. RECIPIENTS CATERED FOR

9 Main Street  
Leixlip  
Co. Kildare  
Tel : 6243964  
Fax : 6243410

Unit 12  
The Village Centre  
Lucan  
Co. Dublin  
Tel : 6282062

Market House  
Dublin Road  
Maynooth  
Co. Kildare  
Tel: 628 6606

47 Dublin St.  
Longford  
Co. Longford  
Tel : 043 41304

## Clubs, Organisations & Societies

entirely voluntary basis. Our general aim is to make people aware of our bird and other wildlife and the absolute necessity of taking action to protect their natural habitat.

Our activities are advertised in the IWC Newsletter which is distributed free to members, in the local press and radio and also through posters in libraries, shops etc.

Tuesday 16th November: Find out about your local Irish Wildbird Conservancy Branch at Blanchardstown Library, Roselawn, Blanchardstown, Co. Dublin. 8.30 pm.

Fri/Sat/Sun 19/20/21 November: IWC Expo '93 - 25th Anniversary Conference and Bird Fair, organised by the Irish Wildbird Conservancy at Howth Lodge Hotel, Howth, Co. Dublin. Details etc. from the IWC at 2804322/2808237.

Saturday 27th November: Coach trip to Boyne Valley and Clogher Head. Details at 573698.

The above activities are open to IWC members and the general public.

### I.C.A. NOTES

The October meeting of Maynooth I.C.A. Guild was held in the I.C.A. Hall, Maynooth on Thursday 7th October. Our President, Imelda Delaney welcomed all the ladies and said she was delighted to see so many new members at the meeting.

### Competitions

By the time these notes are printed, we will have taken part in the Allied Irish Banks sponsored competition in Kill on 27th October. However there are many more competitions coming up in the near future. The Raytex Baking competition for a Christmas cake will be taking place in early November. There are inter-Federation competitions in December for tweed pictures and hand-sewn patchwork cushions.

### Activities

Badminton continues in the Parish Hall every Tuesday and Thursday morning (10.30 - 12.00). May, our Sports Officer, would be delighted to welcome new members to the Badminton mornings. Pitch & Putt for our members, at the local course, has come to an end with the closing of the course for the winter months. However, Kildare County I.C.A. Golfing Society is still looking for new members. Nell, our Crafts Promoter, has Craft nights on Mondays (8.00 pm start) in the I.C.A. Hall. Jointed dolls are being made by some of the ladies at the moment, and it is hoped to make some Christmas gifts and decorations in time for the Festive Season. The bad news is that there will be no pottery classes. Rosemary told us that Bránnaire tests in sweet making, jam making and baking will be coming up soon.

### Crafts Day

The Crafts Promoter for Co. Kildare, Mary O'Gorman, has organised a Crafts Day for the Divine Word Hostel, Maynooth, on 20th November. By the time these notes go to press I'm sure all the classes at the Crafts Day will be fully booked. Wishing Mary, who is one of our own, every success with the Crafts Day.

### C.K.R.

The 15th October saw the return of the ever popular I.C.A. slot on C.K.R. The programme called "Home Truths" goes out on Fridays from 2pm to 3pm.

### Christmas Party

Yes, its that time of year again and Co. Kildare I.C.A. Federation Christmas Party will be held in the Red House on 25th November. Fee is £9.

### Raffle and Competition

Raffle results are:- 1st U. Forde, 2nd C. Harpur and 3rd K. Burns. Our competition for this month was "Something New from Something Old". Breda Cunningham judged the competition and awarded 1st place to R. Hanley, 2nd to B. Moore and 3rd to B. Duffy. Next month's competition will be an Irish/English Quiz.

### Bring and Buy

Kay and Veva proved to be very good auctioneers at this month's Bring and Buy in aid of An Grianán scholarships. Due to the auction we didn't have a guest speaker at this month's meeting.

### Kildare Week

Co. Kildare Federation week in An Grianán next year will be from the 22nd June - 1st July. Anyone interested in this can get further details from Helen Doyle.

### Next Meeting

The next Kildare Federation meeting will be held in Derrinstown on Saturday 27th November (3.00 pm - 6.00 pm). Our next meeting will be held in our hall on Thursday 4th November at 8.00 pm. As we will be having our Ecumenical Service at this meeting, it is hoped that all our members will be able to attend. New members are always welcome.

Connie Harpur,  
P.R.O.



**Visual Image Photography**  
102 Moyglare Village  
Maynooth, Co. Kildare.

Wedding Photography  
Commercial Photography  
Video Production

Contact: Gerald MacCann I.P.P.A. Member  
For Appointment Phone: 01 - 628 6488

Member of Irish Professional Photographers' Association  
Member of the World Council of Professional Photographers

# MEADOWBROOK HEALTH CLUB ENFIELD

Tel: 0405 41280 - 01 6287936

Open For Yearly Membership  
Family -

2 adults and 2 children up to 14 years  
from the Same House

Couples -

Two Adults from Same House

Children (up to 14 years)

Must be accompanied by an Adult

Singles (15 years & over)

Classed as Adults

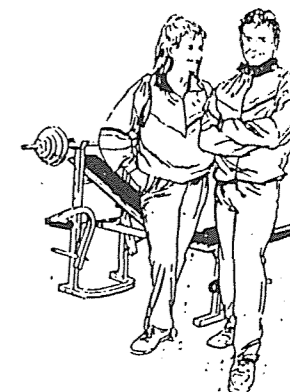
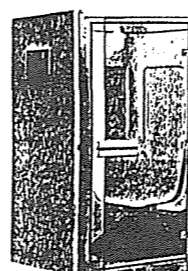

Facilities include full use of swimming pools (indoor & outdoor) sauna, jacuzzi, plunge pool, impulse shower, steam rooms (herbal & standard)

Sunbed Available

Continuous Video Aerobics Daily

Members and Non-Members

Open 7 Days A Week

**ENQUIRIES: TEL: (0405) 41280 - (01) 6287936**

15 MINS. DRIVE FROM MAYNOOTH

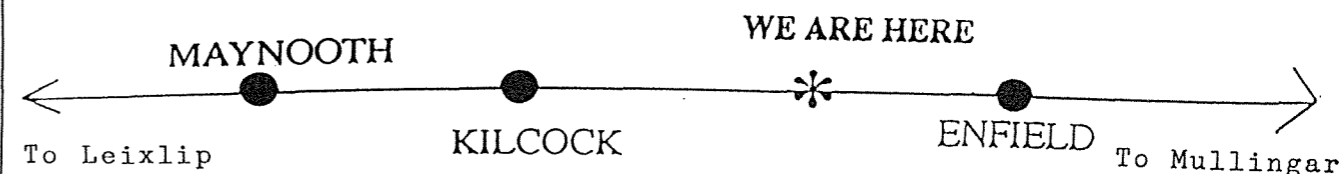

## Clubs, Organisations & Societies

### MAYNOOTH FLOWER AND GARDEN CLUB

Congratulations to our three members who won prizes at the recent Association of Irish Flower Arrangers National Competitions in Cork. Sarah Angel and Noeleen O'Brien represented the Club in the Inter-Club Competition with a wonderful and interesting exhibit titled "Wild Grow the Lilies"! They got a most deserving third place, for their beautiful display of flower arranging at its best.

Our friends and neighbours in Dunboyne just finished ahead of us in second place with their spectacular seascape - Congratulations to all, on your delightful exhibit, Nenagh Flower Club came first with an exhibit titled 'Irish Art'.

Imelda Desmond also achieved great success, with a second prize in her amazing abstract exhibit and third prize with her exhibit titled 'Beauty and the Beast' - a really charming arrangement. Congratulations Imelda.

Now more congratulations to our members who won the club competitions for '92 - '93. List of winners are:- Class A 1st Kathleen Cleary 2nd Felicity Satchwell 3rd Noeleen O'Brien Class B 1st Carmel O'Leary/1st Mary Cleary 3rd Kitty Core Class C 1st Moira Baxter 2nd Annette Carroll 3rd Toni Reid Plant Competition: 1st Moira Baxter 2nd Imelda Desmond 3rd Joan Reynolds

After all these greetings it's back to work for all on November 16th, when it's a work night making figurines in time for all those Christmas decorations. So we will expect to see a large attendance at 8 pm in the Divine Word Hostel on 16th. The December Newsletter we will have a report on the A.G.M. and officers for year ahead.

Moira Baxter  
P.R.O.

### MAYNOOTH PITCH AND PUTT

Myself and Thomas would like to thank all those players who in recent months have had to, on occasions, play in some unusual circumstances. I refer to necessary drainage work that had to take place in order to allow the course function under some kind of normal condition. We apologise to all those players, none of whom complained and who understood the need for this work and we hope it did not hamper their enjoyment of the game.

As a result of our drainage and the timely disappearance of our "3 springs" the course is now appreciably drier under foot, a relief to everyone concerned!!

Due to the high level of disappointment and the amount of enquiries regarding our winter closure we shall endeavour to keep open as long as the weather permits and we would even hope to have a Sunday opening if possible throughout the winter. It must be stressed however that at the first sign of stress or wear on the greens during this period we will close the course. We believe that you will appreciate this as much in the interest of the player as it is in keeping our repair/workload to a minimum.

Tony Bean

### MAYNOOTH OLD PEOPLES' COMMITTEE

As mentioned in last month's issue, our annual 'Sale of Work' will take place on Sunday, November 21st., commencing at 3p.m. (See advertisement elsewhere in this issue.)

In the coming weeks, we will be calling on our usual benefactors who are always so kind and generous to our Committee members when they call.

As you all know by now, all money and goods collected is prudently used for the benefit of our Senior Citizens. We do realise of course, that this time of year tugs heavily on all our purse strings. All we ask is, that you give a little and support us on the day.

We will also have our usual raffle for a Monster Hamper, which is well worth winning. It contains everything for Christmas, from Cornflakes and Jelly, to Turkey, Ham and Whiskey. Tickets will be on sale at Quinnsworth for two weekends prior to the 21st starting on the 11th of Nov. You may also get tickets from any of our committee. So make it a date. Sunday November 21st. a worthwhile afternoon with something for everyone.

Diathermy & Beauty Clinic

### Cameo

Main Street, Maynooth (Beside Barry's Newsagents)  
Phone: 628 6272



Specialising in Electrolysis

Diathermy for Broken Veins, Skin Tags

Cathodermie Facial, Bio-Peeling, High Frequency Facial

Basic Facial Waxing, Eyelash & Eyebrow Tinting

Manicure, Make Up, False Tan

37 Tube Turbo Sunbed

Tues., Thurs: 10 a.m. - 7.30 p.m. Wed., Fri.  
Sat. 10 a.m. - 5.30 p.m. or alternative times by appointment

### BARTONS

Newsagents - Confectioners - Tobacconists

Boxes of Chocolates

Fruit • Magazines • Groceries

Stationery • Ice Cream

Shell Petrol Station

Books

The National Lottery - An Crannchur Naisiunta

## MAYNOOTH OLD PEOPLE'S COMMITTEE

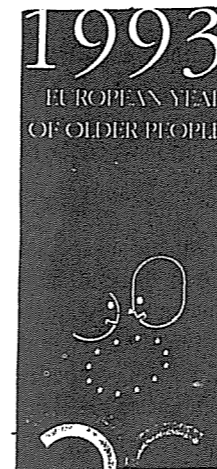

### ANNUAL SALE OF WORK

will take place in the



PARISH HALL  
ON SUNDAY 21ST NOVEMBER

DOORS OPENING 3 PM

*SOMETHING TO SUIT EVERYBODY!*

WHEEL OF FORTUNE  
BOTTLE STALL



WHITE ELEPHANT  
BOOK STALL



CHRISTMAS FAIR, ETC...



HOME PRODUCE CAKES • JAMS ETC.

*As always proceeds from above provides for  
fuel and social outings for our elderly*

**WE KNOW WE CAN RELY ON YOUR  
SUPPORT**



## Clubs, Organisations & Societies

### MAYNOOTH PUPILS VISIT GAIETY THEATRE

On Wednesday 6th of October, a group of twenty students from Maynooth Post Primary School attended "A Winter's Tale" by Shakespeare at the Gaiety Theatre. The tickets were presented to the School courtesy of the National Lottery, who financed this performance for all Schools. Maynooth Post Primary School was represented at this performance by its Drama Group.

The production starred John Nettles from "Bergerac" and was enjoyed by all. Our thanks to Mrs. L. Barry for accompanying our group to the Gaiety. We hope that the National Lottery will repeat this gesture next year.

### MAYNOOTH POST PRIMARY SUCCESS AGAINST KILLUCAN

On Monday the 11th of October, the Maynooth Post Primary School camogie team played against Killucan in the under sixteen Leinster Championships. Maynooth won by 3 goals and 6 points to 1 goal and 2 points. All played well but Carol Cassidy, Una Burke, Emma Fahy and Jackie Kinsella gave a superb performance. Maynooth now advance to meet Banagher Vocational School on Monday 18th of October. Credit is due to Mr. J. Nevin and Miss. N. Mannion for the success of the Maynooth team.

### FIRST YEAR MASS AT MAYNOOTH POST PRIMARY SCHOOL

On Thursday 23rd of September, a Mass for all first year pupils and their parents, was held at Maynooth Post Primary School. The celebrant was Father Oliver Brennan from Maynooth College.

This school Mass is a very important event for several reasons. It is a gathering to ask God for his blessing on all involved in school life. This includes parents, students and all school staff. It is also an opportunity for students to introduce their parents to their teachers. Lastly, it is a welcome on behalf of the school and an ideal way to begin the academic year.

The music for the Mass was prepared by the students themselves as also were the readings and the mimes. These readings were presented in drama in order to involve students in the Liturgy of the Word. The topic for the Gospel was about using the talents that we are given. We hope that our students will develop their own talents as best they can.

The Mass was both a successful and an enjoyable event. Considerable credit for this must go to our school chaplain, Father David Boylan and to the teachers of religion. We are also indebted to the teachers of Home Economics and to some of our senior students, who worked hard in order to provide refreshments. Credit is also due to the teachers involved with first year students and in particular to the school caretakers. Finally, we must thank both the students and their parents, who made this event possible. We wish our students every success both in the school and afterwards.

### MAYNOOTH PAST PUPIL WINS SPORTS SCHOLARSHIP TO U.C.D.

John O'Reilly has gained the distinction of winning a sports scholarship to U.C.D. A native of Dunboyne, he first entered Maynooth Post Primary School in September, 1988 where he has been a student for the past five years. In June of this year he sat the Leaving Certificate Examination where he obtained six honours.

Running was always important to John and he specialised in distances of 400, 800, and 1,500 metres. In 1990 he won the Irish Schools Championships for a distance of 800 metres. He again won the same competition in both 1991 and 1992. Unfortunately, an injury prevented him from competing in the 1993 Championships. Had he won again in 1993, he would have established an unbroken record.

John will now study for an arts degree but his scholarship will cover tuition fees, accommodation, books and travelling expenses to races. His scholarship obliges him to train every day and be available to run for U.C.D. in any competition in which he is entered.

John is the youngest member of his family. He has two brothers and three sisters. Both of his brothers have won scholarships to the U.S.A. His eldest brother competed in the 1988 Olympic Games.

John's advice to up and coming runners is as follows. Concentrate on doing your best. Do not take it too seriously when you are very young. Just run for fun. Wait until you are in your teens before you take it seriously. We in Maynooth Post Primary School wish him the very best of luck in his future career.

### Maynooth Post Primary Tour to Italy

A tour of Italy is planned for fifth year students at Maynooth Post Primary School. They will depart on Wednesday 20th of October at 1400 hours for Rosslare and will depart from Rosslare at 1900 hours for Le Havre where they hope to arrive on Thursday 21st of October at 1700 hours. From Le Havre, they will travel to Rome where they should arrive on Friday 22nd of October at 1500 hours. They will spend Friday, Saturday and Sunday in Rome and on Monday they will depart for Venice via Florence. Monday, Tuesday and Wednesday will be spent in Venice. They will then depart for Paris where they hope to arrive on Thursday at 0800 hours. They will then spend a day in Paris before returning home.

This should be a very educational trip as there are many places of historic interest in also Italy. Considerable credit is due to Mr. S. Griffin for organising the trip. Credit is due to all of the supporting teachers who will accompany the students on the trip.

### A.G.M. of Maynooth Parents Association

The A.G.M. of the Parent's Association of Maynooth Post Primary School was held in the School on Tuesday 12th of October under the chairmanship of Mr. Patrick Halley. It was well attended. Mr. T. Ashe (Principal), gave the keynote address on the Transition Year. The sooner we get our new



# L.S. AUTOS

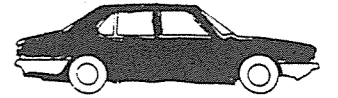

**BALLYGORAN MAYNOOTH  
CO. KILDARE**

**PHONE: (01) 6285532 FAX: (01) 6286777**

**Panel Beating \* Spray Painting \* Colour Matching  
Insurance Claims Handled \* Replacement Car Services  
All Work Approved By Leading Insurance Companies  
Servicing \* Sun Tester \* Electronic Tuning**

**QUALITY USED CARS : FINANCE ARRANGED**

V.W. Passat Saloon '90  
Mercedes 307 Dsl. Van '89  
Opel Kadett Dsl. Saloon '87  
Volvo 740 Est. '86  
Mercedes 230E '82

Mitsubishi Lancer '90  
Daihatsu Charade Dsl. Van '89  
Mazda 323 H.B. '87  
Opel Kadett Est. '85  
Mercedes 250 '81

Fiat Uno '90  
Renault Trafic Van '88  
Daihatsu Charade Dsl. Van '87  
Nissan Sentra '84  
Volvo 244 Saloon '78

**TRADE-INS TO CLEAR**

Opel Ascona '83  
Fiat 127 '82

Ford Escort '82  
Renault 4L '81

**24 HOUR RECOVERY SERVICE**

**PHONE : 088 572726**

# WESTSIDE WASTE

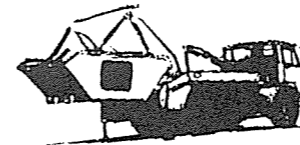

- Industrial
- Domestic
- Commercial
- Mini, Standard
- Large/2 in 1/Roll on
- Guaranteed Prompt Service
- Keen Rates

**6289479 / 6289480 / 6289544**

**Mobile 088-553315**

**Leixlip Road, Maynooth, Co. Kildare.**

## Clubs, Organisations & Societies

extension, the better are our chances of implementing this transition year.

The one thousand pound draw for the School Bond Scheme was won by Mr. and Mrs. Liam Farrell of Carton Court. After the meeting, Mr. S. Griffin spoke to parents of fifth year students who are travelling to Italy on the School tour.

### German Students Visit Maynooth Post Primary School

A party of seventeen German Students and two teachers visited Maynooth Post Primary School. They arrived on the 30th of September and stayed for eight days. This trip was preceded by our trip to Germany. Earlier, Mrs. Carmen Creighton took seventeen Maynooth Students to Germany and the German trip was a return gesture. The German students lived with Maynooth families, attended our school and saw some indigenous Irish Industries such as Avonmore Creamery and Moyglare Stud.

Exchange schemes are very important. They improve the motivation of the students and give a good insight into the culture and daily life of another country. This exchange was project based and was partly funded by Lingua.

Michael J. Walsh

## DEVANEY ACADEMY OF SPEECH & DRAMA

Centres at  
MAYNOOTH • LEIXLIP • CASTLEKNOCK

For further information Telephone: 628 5007

THE ACADEMY ACTS AS AN AGENCY FOR STUDENTS INTERESTED IN FILM/TV OPPORTUNITIES

PROFESSIONAL EXPERIENCED TUTOR

REGISTRATION FOR JANUARY TERM STARTING NOW

COUNSELLING PSYCHOTHERAPY SERVICE MAYNOOTH

INDIVIDUALS • RELATIONSHIPS  
FAMILY • ADDICTIONS  
MARITAL • PHOBIAS

CONTACT: MARY LALOR - MIAC  
FAMILY THERAPIST

TEL. 01 - 627 3909 • FAX. 01 - 627 1606  
FOR APPOINTMENT

## PRESENTATION CONVENT PARENTS' ASSOCIATION

We would like to thank all who supported our fund raiser "Night at the Dogs", it was a tremendous success and would not have been so without the generous response from you the parents, our race sponsors, advertisers, nominators, those who gave donations and all of you who bought raffle tickets. Thank you all.

Due to a typing error in our programme for the night Eugene Mara was omitted from our acknowledgements. Our apologies. Full report on night at our A.G.M. to be held on 29th November 1993. Our guest speaker is Dr. Brendan Byrne who will give a talk on building in schools. All are welcome.

The results of our raffle are follows:

- 1st Prize Catherine Plunkett, Laurence Ave.
- 2nd Prize M. Devaney, Cluain Aoibhinn
- 3rd Prize Marie Walsh, Greenfield
- 4th Prize Margaret Nolan, Maynooth Park
- 5th Prize C. Hardiman, Dublin Road

Hope to see you all at our A.G. M.

Lila Flynn, Chairperson

## NEWTOWN STORES

Beaufield, Maynooth, Co. Kildare.  
Tel. 01 - 628 5833

Opening Hours: 8.00 a.m. - 10.30 p.m.  
Open Everyday including Sunday

Lotto Agent • Groceries • Fuel • Gas  
Fancy Goods • Sweets • Cards • Magazines

Free Delivery Service



Pat Reid & Co. Ltd.

Laragh, Maynooth.  
Tel. 01 - 628 6508  
Mobile: 088 - 575590

Washing Machines • Dishwashers  
Electric Cookers • Tumble Driers  
Vacuum Cleaners • Kettles etc.

Repairs & Sales

## C.K.R. News/Current Affairs and Sports Schedule

97.6FM • News on the Hour • 97.3FM

### WEEKDAYS

6.30a.m. - 10.05a.m.	WAKE UP LEINSTER with Tom Browne	2.00p.m.-3.00p.m.	Points of View, with Tom Dowling
6.45	Farm News		CKR's daily magazine show covering current issues, guests in the news and tackling the local issues.
7.00	IRN News	3.00-4.00	The Afternoon Drive, with Vincent O'Sullivan.
7.04	Tom's Alarm Call Comp.		Regional News.
7.15	Who's Up This Morning?	3.00	What's Coming Up on the Programme
7.20	Weather Update	3.05	Yes and No Game
7.30	The Amazing News Headlines		Weather Forecast
	Mystery Voice (taking three live callers on-air)	3.15	Interesting Facts from the Book of the Bizarre. Bingo Numbers.
7.40	Headlines from the Newspapers	3.20	Yes and No Game
	IRN News followed by Obituaries	3.30	IRN News
7.50	Song of the Day (with a vote line open)	3.45	Yes and No Game
	The Morning Papers with Caroline O'Brien	4.00	Weather Forecast
8.00	Traffic Update	4.15	Book of the Bizarre
8.04	Weather Update	4.20	"Beat the Bong"
8.05	Amazing News Headlines Update	4.30	IRN News
	Leinster's Trivia Challenge	4.45	Main Headlines from Evening Papers
8.15	Sports with Caroline O'Brien	5.00	Traffic Reports
8.20	Traffic Update	5.05	Weather and Driving Conditions
8.22	Weather Update		Community Diary
8.30	Update	5.15	Traffic Reports
	Sports with Caroline O'Brien	5.20	Sport
8.40	Traffic Update (No. 2)	5.30	IRN News
8.45	Song of the Day	5.40	Open Line, with Una Power
8.50	IRN News	5.45	Juke Box Gems, with Noel McCaul
9.00	Job Spot	6.00-6.10	Golden musical memories of the 50s, 60s, 70s and 80s, including the Showbiz Birthdays and also the featured year.
9.04	The Rocky Railroad Feature (15 mins. Country & Western)	6.10	On a Country Road, with Brendan Bambrick
9.15	The Telecom Diary	7.00	Quality Country, American and Irish with guests, competitions and the Gig Guide.
	The 15 Minute Love Affair		The New Niteflite, with Sean Ferguson
9.30	Tom's Top Story	9.00-11.00	Overnight with Supergold
9.45	Racing Preview		CKR and Europe's Premier Satellite station combine for music through the night.
9.50	IRN News followed by Obituaries		
10.00	Morning All with Chris Walsh	11.00-3.00a.m.	
10.04	It's the Elder Lemon and the World is his Oyster. Chat, music, guests, phone-in & competitions	3.00-6.30	
10.05am-12.50pm	Regional News and Sport		
	The Bargain Counter, with Noel McCaul & Kay Hendrick.		
12.50-1.10			
1.10-2.00			

### SATURDAY PROGRAMME SCHEDULE

7.00a.m.	Saturday Showtime, with Chris Walsh.
	Entertainment for all the family.
10.00	An Bóthar Eile, with Ann Conway.
11.30	The Essential Selection, with Noel McCaul.
	Solid Gold Hits and Fascinating Trivia.
2.00	Saturday Sport, with Clem Ryan.
	Music and Sport.
6.04	5.30-6.00: Sports round up.
	Soundsearch, with Damien McRory.
7.00	The Irish Top 30, with Sean Ferguson.
9.30	The Nightshift, with John Troy.

### SUNDAY PROGRAMME SCHEDULE

7.00 a.m.	Brendan Bambrick.
	Easy listening sounds.
10.00	It's Tom Browne.
	Lots of phone calls. A chance for you to go on air with your request on (0503) 41044.
1.00	Country Forum, with Jim Norton and Monica Carr.
2.00	The Purple Heather, with Clem Ryan.
3.00	CKR's Traditional Music Programme.
	Sunday Sportsbeat, with Ronan Jennings and Clem Ryan.
7.00	Leisure Time Listening.
8.00	Focus on Irish Music Scene, with Jarlath Judge.
10.00	Nightshift, with John Troy.
2.00a.m.	Overnight with Supergold.

CKR Radio: Lismard House, Tullow Street, Carlow. Tel: 0503 41044 (6 lines). 0503 41048 Advertising. 0503 41046 Newsroom. 0503 41047 Fax. Main Street, Maynooth. Tel: 016289558, Fax 01 6289558  
ACC House, South Main Street, Naas, Co. Kildare. Tel: 045 79666 - Office Hours, 045 97611

## Clubs, Organisations & Societies

### ROYAL CANAL AMENITY GROUP, MAYNOOTH BRANCH

Cómhairle Aisinteachta An Chanáil Ríoga, Cumann Maigh Nuadh



L to R: Sean "Buggy" Horan, Joe Gannon, David Joyce, George Houghton, Tadhg Walsh, Tony Kelly, Pat Myles, Jimmy McKeown, Linus Phipps and Kevin Breslin, Supervisor in barrow. Not included in photo: Mel Duffy (Bookkeeper), Julie Purcell, Stan Gibson, Tom Ward

#### SES Scheme

Work continues at the Harbour and also at Pike Bridge. In addition two of our SES workers are engaged at maintenance and restoration at the canal boathouse at Confey near Leixlip. This sharing arrangement is with the sponsors of another SES scheme, and the experiment is working well. The gradual onset of autumn and winter will inevitably slow down progress a bit, but enthusiasm remains consistently high.

#### Miss Royal Canal and Fashion Show

Another reminder that the selection of the 1993 Miss Royal Canal will take place at the Setanta House Hotel, Celbridge at 8 pm onwards on Thursday, 18th November. This has been a sell-out event each year, and the stars of the show are the contestants. We have assembled a wide range of valuable prizes. There will be a press reception some weeks in advance. The contestants will also meet the panel of judges on a friendly informal basis at the press and cocktail reception. This year's compere will be **Liam Quigley of 98FM**. Your £5 ticket will also include our ever - Popular Fashion Show, where again the stars are local models who are Super Models on the night. Maynooth's King of Comedy and Bachelor of the Year, **Eugene Fitzpatrick** will also entertain you during the show. The night concludes with a disco where we hope love stories will begin and not end. The best dressed man and lady will win separate prizes, while there will be mega-prizes for the raffle. Come early to ensure a seat.

#### LITTER

We had an encouraging response to our anti-litter campaign. As we stated in our October notes we have removed bags of rubbish from the canal area throughout the years. Invariably these bags and their contents clearly identified the very people who dumped the bags.

#### BODIES

The search goes on. Our October invitation led to a number of enquiries. If you have an interest in your locality, fishing conservation, nature or the environment make contact with us through the Newsletter. We will arrange to meet on a friendly and informal basis, and discuss our operation with no strings attached or obligation on your part to continue.

Slán go fóill

### SCOUT NEWS

November, and judging by the clear weather we had last month it looks like either this summer has arrived three months late or next summer has arrived eight months early. Still no matter how cold the weather is at this time of year, the fact that it's clear means that the intrepid members of the unit are out in force.

Last month saw the official opening of the Scout Year in the region with the regional parade in Kilcloone. Representatives of every Beaver Colony, Cub Pack, Scout Troop and Venture Group were there along with leaders and members of the regional administrative team. Also present were the chief scout, Mr. Joe Lawlor and the chief commissioner, Mr Michael Hasset. Maynooth of course were well represented with some 40 members making the trip.

Also last month the unit took part in its annual fundraising event, the "mile of money". Located at several prominent locations throughout the town, we collected from nine until six and as usual the response from the good people of Maynooth was excellent. A big thank you to all who contributed, it is through your support that we are able to continue functioning as a unit.

Finally we in the unit would like to extend the best of luck to our newly revived Venture Group which by now is in full swing. Go n-éir an tádth libh.

So that's it then. The New Scouting year is officially under way. We hope to have for next month the timetable of forthcoming events for the year for all sections so until then Bí Ullamh.

Vinny

### SOMERSAULT TO SUCCESS

Feeling energetic and fit? Find out if it's true by attending gymnastics classes in the Parish Hall on Monday afternoon. Ger Hogan, Trainer, will start you off and progress you to a more advanced level (who knows, there may be a budding Olympian!!!) Age is no limit either as he said in his own words, "anyone from three to whatever is welcome." The classes on Monday are split into two sessions: from 2.00 - 3.00 - Beginners at a cost of £1.50 for the hour, and from 3.00 - 5.00 for older and more advanced pupils at a cost of £2.50 for the two hours. So all you've got to do is get your runners on and be there on Monday afternoon.

### GREENFIELD SUPERMARKET MAYNOOTH & CELBRIDGE

Maynooth 9 a.m. - 10 p.m. (Mon to Fri)  
9 a.m. - 8 p.m. (Saturday)  
10 a.m. - 3 p.m. (Sunday)

Monthly Specials in every Department  
One Free I.S.A.C. Stamp with every £1 you spend  
for the gift you always wanted  
Spend £5 and you receive a free ticket which will  
enter you in our monthly draw

Agent for Lottery • Gas • Coal • Briquettes

## MAYNOOTH PHOTO CENTRE

Dublin Road, Maynooth, Co. Kildare - Telephone: (01) 6285607

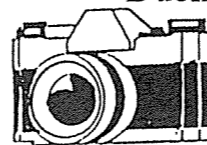

1 HOUR FILM PROCESSING WITH  
EXCELLENT QUALITY - ON THE PREMISES  
ENLARGEMENT - COLOUR OR BLACK/WHITE



CHRISTMAS  
CAMERAS  
PRESENTS  
SEGA  
CHRISTMAS  
MEGA DRIVE

PRESENTS  
FRAMES  
CHRISTMAS  
MASTER SYSTEM  
PRESENTS  
CAMERAS

DEPOSITS  
TAKEN  
PRESENTS  
CAMERAS  
ALBUMS  
SEGA

FILM  
PROCESSING  
GIFT  
VOUCHERS  
PRESENTS  
CHRISTMAS

Free

ALBUM WITH EVERY FILM PROCESSED

## MAYNOOTH JEWELLERS

MAIN STREET, MAYNOOTH, CO. KILDARE

PHONE : (01) 6285946

VISA

STOCKISTS OF ALL LEADING WATCH BRANDS

SEIKO \* ROVADA \* CITIZEN \* ADEC \* Q&Q \* DIGITAL

A LARGE SELECTION OF

9CT. GOLD JEWELLERY \* ROLLED GOLD \* SILVER JEWELLERY

BIROS & LIGHTERS

CAVAN \* GALWAY \* TIPPERARY CRYSTALS IN STOCK

BELLEEK & DONEGAL CHINA \* WATCHES & JEWELLERY REPAIRED

Tel: 6286202

### S. UA BUACHALLA

Main Street, Maynooth

Calor Kosangas

### NOVEMBER SPECIALS

10 BULBS £ 3.90  
ELECTRIC KETTLES £15.65  
ELECTRIC IRONS £20.39  
LONG LIFE BULBS £13.98  
ELECTRIC IRON £23.35  
DESK LAMPS £ 7.55

FIREGUARDS FROM £ 7.29  
FIREGUARDS FROM £29.95  
(for gas heaters)  
NURSERY GUARD £34.85  
16" FIRE BASKETS £ 8.45  
18" FIRE BASKETS £10.95  
16" COPPER FRONTS £14.79  
18" COPPER FRONTS £17.95

GAS HEATER REGULATOR 1 FILL GAS FREE ONLY £109.00

COAL

GAS

BRIQUETTES

## Clubs, Organisations & Societies

### St. Mary's B.N.S. Sponsored Cycle

Our sponsored cycle was held this year on Sunday, 10th October. Although the days before were wet and windy and the forecast for the weekend equally as bad, Sunday turned out to be a glorious day and made the cycle a really enjoyable outing.

Well over two hundred boys plus many of their parents took part and everyone arrived back safe and sound. The school Board of Management would like to thank most sincerely all who took part and also all those generous parents and friends who sponsored the children. The Board would also like to thank the many parents who helped by their hard work to make the day a huge success.

Lastly, the board owes a great debt of gratitude to the many local firms who contribute generously to all our functions including this year's sponsored cycle.

A most sincere thank you to: Joe Duignan, Mallen Oil; Derrinstown Stud; Moyglare Stud; Bank of Ireland; A.I.B.; Brian Noone; Maynooth University Book Shop; Bartons Transport; Frank Regan; Coyne & Bergin; Travel Options; Gerard Brady; Brian Connaughton; Ulster Bank; Paddy Lavin; Tom Geraghty and Quinnsnorth.

### STUDENT NEWS

We are writing this letter, basically, as an explanation and an apology for what happened during the first week of term in the College.

As a result of there being no Students' Union function hall on Campus until Christmas it was decided that for the first week we would put up a Marquee to provide some form of entertainment for the new First Year students arriving in the College.

As regards the students attending the two functions, they seemed happy with what was provided and in that sense one half of the week went well, though we realise that as regards the residents of Maynooth it was a thoughtless move and therefore we would like to apologise unreservedly for any disturbance or inconvenience caused on either of the two nights, though at the end of the day all we were trying to do was our job and I can assure everyone that the Marquee will not be put up again.

Hopefully this will not affect the good relations that have been built up over the summer between the students and the community.

*Denis Clohessy Joe Donnelly*  
Vice-President President

### TAE KWON-DO NEWS

For the first time since its opening in 1985, Maynooth now has two 2nd Dan black-belts.

Seán Foy (Lenster Cottages) and Antoinette Mooney (Greenfield) were promoted to 2nd Dan by the examining board of the Republic of Ireland Tae Kwon-Do Association in Waterford at the end of September. It is a very fine achievement by these two members and will be the first in a line to follow.

During the same weekend, the R.I.T.A. National Championships also took place. Maynooth did quite well: Stephen Hallinan 1 gold and 1 bronze, Keith Fleming 1 gold, Ivan McNamee 1 silver, Antoinette Mooney 2 bronze.

Quite a number of colour belt members went up another rung in the ladder when Mr Anthony Phelan, 6th Dan of the R.I.T.A. visited Maynooth early in October. Promoted were: Catherine Duff, John Hawthorne, Gemma Maguire, Irene Kearney, Eloise Mac an Airchinnigh, Ivan McNamee, Dermot O'Rourke, Gavin Dunne, Ann Burns. Well done!

#### Special Announcement

On Wednesday November 10th, an all adult Beginners class will take place in Maynooth's Tae Kwon-Do School. This will be strictly for the over 18's, both Ladies and Gents. This is an unusual venture as classes have usually been mixed with Juniors. This Beginners Group will get under way at 7p.m. on Wednesdays from the 11th, in the Post Primary School Hall. No previous experience is necessary - just a track-suit and a willingness to learn.

Anyone who did train in the past and discontinued are always welcome to visit and maybe get started again. Grades attained in the past still hold.

*Gerard McClelland 3rd Dan Instructor*  
Enquiries 6280868

### TUG 'O WAR

Maynooth Tug 'o War ended on a sparkling note when in the last competition of the year, the Bradys team of George Gallagher lifted the Hitchin' Post Cup, on a bright sunny Sunday, October 17th. Pulling in front of their home crowd, the team dug very deep to deprive a resurgent Riverstown (A) contingent of this coveted prize. It was a nailbiting finish as the local side, that did not know how to say die, scrambled, scraped and dug their way through the unending pain of contest to emerge victorious amid scenes of emotion and jubilation.

This success crowns a few months of hard training and was a deserved award for the team which organised this event. The Middleshop, Leixlip, finished high in the rankings with another local team, Rockafellas, putting up a good display. The winning squad were: John Gallagher, Gerry Ryan, Jimmy Towey, George Gallagher, John O'Mahoney, Tony Dempsey, Seamus Cauley and Michael O'Rourke as anchor man, with

continued

## GERARD MULCAHY FAMILY BUTCHER

GREENFIELD SHOPPING CENTRE PHONE : 6286317

FINEST QUALITY MEAT  
HOME COOKED HAMS • BAKED HAMS  
ROAST BEEF • FRESHLY MADE SALADS

MULCAHYS PORK SAUSAGES AND PUDDINGS MADE DAILY  
MULCAHYS LOW SALT BACON (HOME CURED)

*Join Our Christmas Club*

## MOYGLARE GOLF COURSE

PAR 3

Maynooth, Co. Kildare  
Telephone: 6286339

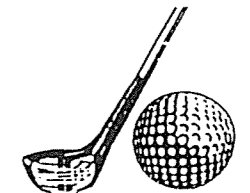

#### GREEN FEES

Monday - Friday £3.00

Saturday - Sunday & Bank Holidays £4

Under 15 - £1.50 Mon - Fri

- £2.00 Sat - Sun

- & Bank Holidays

*Turkey Competitions Every Sunday Morning*



## COONAN

We have the best clients  
We get the best prices



**Just In:** Three attractive new Bungalows  
in Maynooth & Summerhill  
on between 1/2 & 3 acres.  
New semi-detached properties in  
College Green, Kingsbry & Clane

**SOLD**

Newtown House, Kilcock  
on c. 126 acres  
withdrawn at auction at £237, 000  
and sold later for a higher figure

**SOLD**

In recent weeks a selection of houses in  
Kingsbry, Moyglare, Beaufield and Laurence  
Avenue sold at satisfactory prices

*Auctioneers \* Estate Agents \* Property Consultants \* Valuers*  
*Property House, Maynooth, Co Kildare Tel: 01 6286128 • Fax: 01 6286726*

Paddy Reid, Aidan Mulhall, Anthony Mooney, Jonathon Gallagher as waterman. Nicholas Donovan and myself battled it out for the coaching job. Now we can all "go to ground" for the winter and who knows what will happen next year.

Willie Healy

## CENTRA

MAIN STREET, MAYNOOTH  
TEL. 628 5247

GROCERIES • DELICATESSEN  
FRUIT & VEG. • BRIQUETTES

CALL IN FOR YOUR EVERYDAY NEEDS  
OPEN 7 DAYS  
FREE DELIVERY SERVICE

## MARY COWHEY & CO. SOLICITORS

- Litigation & Accident Claims
- Wills & Probate
- Confidential Independent Legal Advice
- Residential, Commercial Sales & Purchases
- General Legal Services

MAIN STREET, MAYNOOTH, COUNTY KILDARE  
TEL. 628 5711 • FAX. 628 5613

## RICHARD'S HARDWARE

THE QUARRY, DUBLIN ROAD,  
CELBRIDGE  
PHONE: 628 8545 • 627 1529

CEMENT • SAND • GRAVEL • TIMBER  
EVERYTHING FOR DIY  
DELIVERY SERVICE

## BEAUFIELD AREA RESIDENTS' ASSOCIATION

Dear Residents,  
Our sports day held in September was a huge success for all of those involved. The children had a wonderful day with lots of prizes and sweets for all.

We wish to thank our sponsors, Brian Connaughton of Newtown Stores, Tom Geraghty of Greenfield Supermarket, The Computer Training Institute, Coca-Cola, and Francis Thornton Joinery for their generosity and support. A special thank you to Mr. Harry Malone for the medals.

We would like to take this opportunity to introduce the children in the estate to Bertie and Rebecca Apple. Together they form the Bara Bears. You will find them from time to time on B.A.R.A. information sheets. So look out for them in the future.

The committee would like to thank all those volunteers who helped with the sports day. We plan to organise a children's party at Christmas. We would be grateful for your assistance and suggestions. So all of those who would like to help out should contact Pat Hendrick at 18 Beaufield Green.

Pat Hendrick (BARA Committee)

## GREENFIELDS ESTATE RESIDENTS' ASSOCIATION

The estate grass cutting for 1993 was undertaken by a contractor. Judging by the feedback by our members this was a great success. Remaining subs will be collected within the next few weeks.

Laurence Avenue  
The Association has written to Maynooth Community Council, looking for an update and future plans in relation to the proposed cut off of Laurence Ave. We shall keep you advised.

R Farrell P.R.O.

## CARLTON CLEANERS

SPECIALISTS IN  
EVENING WEAR, CURTAIN CARE  
SHIRT & LAUNDRY SERVICE

SAME DAY SERVICE  
INCLUDING SATURDAY  
OPEN 6 DAYS

MAYNOOTH SHOPPING CENTRE  
TEL. 628 5511

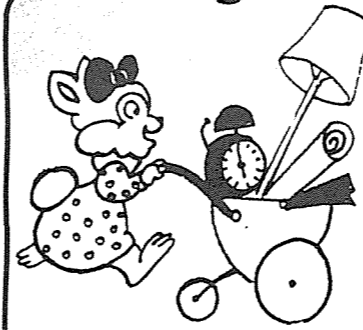

# House Pride

11/12 Maynooth Shopping Centre

Telephone: (01) 6285544.

WALLPAPER  
PAINTS  
PAINT ACCESORIES  
HOUSEHOLD GOODS

STOCKISTS OF  
BRIQUETTES AND GAS

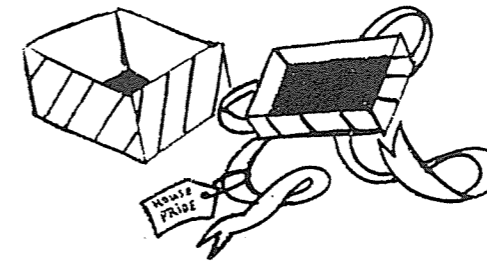

## Books and

## Booktokens



Make Great Gifts  
from Your Bookshop

## The Maynooth Bookshop

The Square, Maynooth  
Phone 6286702



**BIN SPY REPORT**

KEEP MAYNOOTH TIDY THEY SAY! Yet it is evident from our findings that Maynooth is far from litter free. The reasons for the latter in our opinion are as follows:

- 1.Shortage of bins in the town due to the cost of installing same (around £100 each)
- 2.Shortage of staff to maintain a good standard of cleanliness (only one at present)

Of course one could use the worn out argument that it's all the fault of students! However, in our findings we found the town just as dirty before the students came back. Thus, this argument is thrown out the window.

Besides the litter thrown on the street by environmentally unfriendly people, there were evident efforts to dispose of litter in overflowing bins (as seen in the photograph).

Our main question from our findings would be - who's at fault?  
Is it the council or the people?

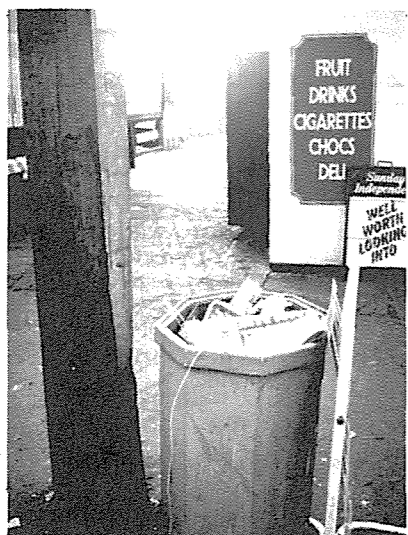

**MURPHY BROS. UNDERTAKERS**  
TEL. 045 - 97397

Complete Funeral Service to Maynooth and surrounding areas for many years.

Tel. Naas 045 - 97397 Day or Night  
Funeral Home Now Available

Local Agent: Paddy Desmond  
Main Street, Maynooth.  
Tel. 628 6366

**BOXING**

**FROM MAYNOOTH TO MANHATTAN**

'Home was the Hero' was the atmosphere in Brady's The Clock House, Maynooth on Saturday 25th September as young Jimmy McMahon rubbed shoulders with friends and locals having a well earned pint of beer. Jimmy, son of Paddy and Norah McMahon of Mulhussey Maynooth had just returned from a gruelling professional boxing campaign in New York, which saw him clock up thirteen successive wins on the trot.

The previous Friday night, over a hundred local supporters had travelled to the Basketball Arena in Tallaght to welcome Jimmy home and see him beat professional English boxer Dave Lovell with competence and style. It was a fight which McMahon won with commanding and aggressive punching, constantly pinning his opponent on the ropes. The only time his defensive shield was breached was in the fourth round of the six- round contest, when in a moment of over confidence and brashness he took a heavy blow from Lovell. However, the strong and dogged McMahon fought back all the harder and won the fight outright on points.

**Come On Jimmy!**

The Maynooth contingent, which filled a full section of the arena were ecstatic and thrilled, having constantly roared 'Come on Jimmy'. It was with pride and satisfaction that they all headed back to Maynooth especially those in the back of Micky's bus. For most of the fans it was the first fight they had ever attended. Yet as Martin Tarpey said, "We were all experts".

Many of Brady's clientele know Jimmy very well, for it was Noel Brady who gave him his first job. Locals such as Nicholas Donovan and P.J. Bennett have followed his career very closely. P.J. recalls going to fights with him and how the young teenager looked so light and small that you would hardly think that he would be able to lift a pint on to the counter.

How this six foot, twenty four year old champion fighter rose Ben Hur-like among the small farmers of the Kildare/Meath border is a phenomenal success. It is the stuff dreams are made of. Indeed, Jimmy's interest in boxing began when as a young boy he watched fights on television, involving the likes of Mohammed Ali and George Foreman. From the age of six he was a wild, tough lad, well able to fight his own battles.

His career began when aged 11 years, Willie Quinn, who worked with his father Paddy at the time, brought him to Kilcock Boxing Club for training. It was the 'one to one' combat of the game which attracted Jimmy to boxing. In underage boxing with Kilcock and Enfield clubs, he won the Kildare Championship and four league titles. This was to signal the potential of the youngster who went on to win the Leinster Youth Championship in 1985 and 1986. At this time he was not taking boxing too seriously as he worked away in Brady's. He decided to hit the States and New York where his brother Michael worked as a foreman in construction. There, he saw a lot of fighting and people and trainers were telling him that he could do something with his talent. He met up with Jim

McDonagh formerly of Enfield Boxing Club and Gleeson's Gym became, and still is, the centre of this young man's life. Another man who was quick to recognise Jimmy's ability was Terry Atlas, trainer and manager, who also discovered boxer Mike Tyson. Before his death he passed Jimmy's management on to Joe Baffi, of the Baffi Brothers Training Camp, saying, "Mind this lad, he is going to be good".

**Golden Gloves**

Jimmy's career as an amateur fighter really took off and he went on to win the Empire State Games in the welterweight division, (which is under 11 stone). Jimmy usually fights at about 10 and a half stone weight. He was twice a finalist in the Golden Gloves Boxing Competition. He only just lost out in a suspect split decision, against the run of the fight, to the amazement of his followers and many commentators. His disappointment led him to consider other options and he decided to go professional, thus ending five years of American amateur boxing, from 1986 to 1991.

Around this time he was being offered money to fight and he competed against some Irish team members, beating Patrick Keogh, Irish Champion in junior middle weight.

As a professional the man from Mulhussey took on Manhattan with a dream start winning thirteen fights on the trot with six knockouts and no losses.

Jimmy continues to train in Gleesons Gym, New York, where he spars with top class boxers and some World champions. He gave me an insight into the boxing life where you literally just "sleep, eat and train". You have to sacrifice a lot and winning is everything. According to Jimmy boxing is 80% mental. You have to be so mentally prepared that pain doesn't bother you. Boxing is a tough game and pain makes you fight right back.

His next target is the European Welterweight Title if the right offer comes along. If not - it's no big deal. If he wins the American Boxing Association belt he will also be eligible for a shot at the World Title. That's all further down the road as Jimmy sees himself spending another four to five years in the game.

Speaking of the Tallaght Match he said "The support was unbelievable, it felt good to come back and get a win under my belt". Jimmy is back in the States after a two week break and we wish him every success with his future plans. One thing for sure, this pleasant and down to earth young man has lost none of the values of friendliness and helpfulness of his upbringing and is doing his family, Kilcloon and his hometown proud.

*Willie Healy*

**CHILDREN'S BOOK WEEK**  
15th October - 21st October

Children's Book Week at the Maynooth Public Library got off to a good start with a visit from the children's author, Pauline Devine, who read an extract from her popular book "The Hungry Horse".

This was accompanied by some slides showing the illustrations and animals she used as an inspiration for her work. Pauline has a new book "Best Friends" which is due out in early November and is eagerly awaited by all her readers.

Congratulations to the Library staff for their organisation of the Book Week.

Details of competition winners will be published in next month's issue.

**Ford** **DERMOT KELLY LIMITED**  
KILCOCK. TEL. 628 7311

**FOR TOP VALUE CONTACT US FIRST FOR  
BODY REPAIRS - SERVICE & PARTS**

**NEW & USED CARS & VANS  
TEXACO HEATING & FUEL OIL**

**TEL. 628 7311**

**NUZSTOP**

Main Street, Maynooth. Tel. 628 6072

Specialise in Cards • Cooked Meats • Gifts  
Toys • Daily Papers • Magazines  
Stationery • Cigarettes • Sweets  
Chocolates • Light Grocery  
also Silver Ware • T-Shirts • Back patches

Opening Hours  
7 a.m. - 9.30 p.m. (Mon. - Fri.)  
8.00 a.m. - 8.30 p.m. (Sat., Sun.)

## Features

### DELICIOUSLY SIMPLE

#### A Centuries Old Recipe For Christmas Plum Pudding

8 ozs. breadcrumbs	6 eggs
8 ozs. brown sugar	1 large grated cooking apple
8 ozs. raisins	1 level teaspoon mixed spice
8 ozs. sultanas	2 tablespoons treacle
8 ozs. currants	1/2 teaspoon each of grated 8
ozs. chopped suet	cinnamon and nutmeg
4 ozs. flour	1/4 teaspoon each of ground
4 ozs. glace cherries	cloves and ginger
6 ozs. finely chopped mixed peel	1/2 pint stout
3 ozs. roughly chopped almonds	1/4 teaspoon salt

Sift the flour with the salt and spices; add to the breadcrumbs and mix in the sugar. Sift well, add the suet, then the cleaned prepared fruit, almonds and grated apple. Warm the treacle slightly and add to the well-beaten eggs. Stir into the dry mixture. Mix well, cover and stand for 24 hours.

Beat well, add in stout. Mixture should be soft enough to drop off the spoon but not soft enough to glide off. If a little extra liquid is needed to get this consistency, add a little water carefully.

Divide equally between three 3-pint bowls. Cover with greaseproof paper, then with a scalded and floured cloth. Tie down securely. Bring ends of pudding cloth back over the bowl and tie to form a secure handle for lifting up puddings when cooked.

Steam for seven hours. Lift up and allow to drain before storing. Allow another two full hours' steaming before serving. Have hot water come up only three-quarters the way to the top of pudding basin. Keep an even steady heat all through cooking. Each pudding is sufficient for 5 to 6 average servings, so, if you want only one such pudding, use one-third of all the above measurements of ingredients.

By the way, beef suet is easier to chop if a little sugar or flour is added to it.

#### Boiled Crubeens (Pig's Feet)

(Crubeens is the Irish name for pig's trotters.)

6 pig's trotters (from the hind leg)  
12 peppercorns  
1 onion stuck with 6 cloves  
Salt  
1 carrot  
1 bunch parsley  
1 bay leaf  
1 sprig thyme

Throw everything into a pot and cover with water. Bring slowly to a boil and simmer for 3 hours. Eat hot or cold. 2 servings.

Crubeens should always be eaten with your fingers. They lose half their magic if you attack them with a refined knife and fork.

#### Typical Irish Broth

908g/2 lb boiling beef or a fowl  
2 medium onions  
3400ml/6 pints water  
2 medium carrots  
113g/4 oz. pearl barley  
57g/2 oz. oatmeal  
few stalks celery  
pepper and salt

Put meat or fowl in cold water with pepper, salt and barley. Bring to the boil and simmer. Prepare the vegetables and add to the meat together with the oatmeal. Simmer for about 2 1/2 hours.

### DESIGNER/DRESSMAKER MAYNOOTH

### FOR BRIDAL EVENING & ALL SPECIAL OCCASION WEAR

FOR APPOINTMENT  
PHONE: 628 9645

## KIERNANS

Main Street, Maynooth. Tel. 628 6294

Groceries • Confectionery  
Cooked Meats • Stationery  
Newspapers • Chocolates  
Fancy Goods • Toys  
Large Selection of Greeting Cards

Open 8.30 a.m. - 7.00 p.m. Each Day

# TOWN CENTRE FUELS

Doctor's Lane, Maynooth, Co. Kildare.  
Ph. 01 - 6286853

DRIVE IN FUEL DEPOT  
COMPLETE RANGE OF FUELS  
POLISH COAL, TEXAN COAL,  
SUPER COAL

BLENDED ANTHRACITE &  
EXTRACITE  
COAL NUGGETS AND  
SMOKELESS FUELS

All Bags Sealed - Weight Guaranteed

SAME DAY DELIVERY SERVICE

WE  
ARE HERE

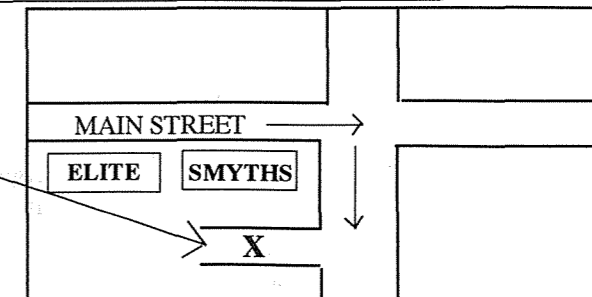

IARNRÓD  
ÉIREANN



WE GO FURTHER TO GET YOU THERE

From Maynooth	ADULT	ADULT	CHILD	CHILD	STUDENT	STUDENT
	Single Day Ret.	Monthly Return	Single Return	Monthly Return	Single Day Ret.	Monthly Return
	£	£	£	£	£	£
MULLINGAR	6.50	8.50	3.50	4.50	4.50	6.00
LONGFORD	8.50	10.00	4.50	5.00	6.00	8.00
SLIGO	8.50	11.00	4.50	5.50	6.00	8.00

**FIELD DAY**

Joe Donnelly, President of the Students' Union, with the help of other groups within the College (Drama, Football and Juggling), are holding a Field Day in the College Sports Complex on November 6th.

All young people in Maynooth are welcome to attend, bring their parents, and make a family day of it.

Test your skills against those of the Students in many areas of sport or join in with the Drama or Juggling Groups.

Many thanks to Marie Gleeson, Maynooth Athletics Club, who has volunteered to help with the organisation.

**GARDA TALK**

**Combatting Violence Against Women:**

In an ever changing society, crimes against women and children are on the increase. Some women may be hesitant to report acts of physical or sexual violence but the Gardai wish to assure everyone that there are ample services in place to assist them and process effectively all complaints. Reporting a matter to the Gardai does not necessarily lead to a court case as many citizens simply approach the Gardai for advice on the options open to them and the availability of relevant agencies. Outlined hereunder is a synopsis of the appropriate information identified with this subject.

**Who can be Raped and who Commits Rape?**

Anybody can be raped anytime, anywhere. Women who are raped often know the person who raped them. He can be their husband, boyfriend, partner, neighbour or a complete stranger.

**If You Are Raped:**

If you are raped remember at all times that you are not to blame. The rapist is the person, who commits the crime, NOT YOU.

**Help Is Available 24 Hours a Day:**

If you are raped or subjected to an indecent assault help is immediately available to you from the Gardai and other agencies such as the Rape Crisis Centre 24 hours a day.

**How The Gardai Can Support You:**

At any time, day or night, trained Gardai can arrange for you to receive medical care and advice. Advice is widely available to you on the many different counselling and support services. If you are the unfortunate victim of one of those crimes, the priority is to look after you and trained members of the force are in place at every stage of the investigation.

**What Is Domestic Violence?**

If anybody in the home causes or even threatens or attempts to cause harm to you - it is a crime. This type of crime not only includes physical harm but also includes mental cruelty and sexual abuse.

**Who Can Be Affected by Domestic Violence?**

Domestic violence against women is a far more common social problem than many people might think. It's a crime which can affect children as well. A child who witnesses violence between parents may learn to accept it as a way of life and at a later stage may become involved in similar behaviour himself.

**Who Commits Domestic violence?**

As a general rule it is a husband or partner who commits this shattering crime against women. To the public he may appear to be a warm, loving person and a most law abiding citizen. Often such an individual will absolutely refuse to accept that he is the person responsible for this destructive, turbulent behaviour. In instances such persons believe that their abusive conduct in the home is justified.

**If You Are Subjected To Domestic violence:**

It's imperative that you know that no one - nobody at all - has the right to assault you. You can stop it immediately by getting the assistance of the Gardai and other agencies such as Women's Aid.

**Again Help Is Available 24 Hours A Day:**

If you suffer from domestic violence professional Gardai will give immediate advice and guidance. At your request a female Garda can be made available to support you throughout such a traumatic experience. Similar to rape, the Gardai can put you in contact with other organisations, who can give you counselling, advice or refuge.

**The Gardai Can Support You In The Following Way:**

The Gardai will advise you on the Agencies who can support and counsel you in seeking Protection/Barring Orders from the District Court. If you are not married and are the subject of violence you can still apply for a Court Order to prevent further abuse.

**Save All Evidence You Can:**

Women who are subjected to family violence often feel isolated, vulnerable and afraid. Where possible, you should save all evidence of attack, which may in course assist the Gardai in effecting arrest and prosecution.

**Garda Procedures:**

If the victim does choose to make a formal complaint the investigating Gardai will take a written statement outlining details of the ill-treatment etc. and identifying the culprit. A Garda file is then submitted for instructions whether to prosecute or not. Assuming prosecutions ensue the matter is dealt with expeditiously in the District Court. More serious cases are dealt with in the higher Circuit Court.

**Protection/Barring Orders:**

Victims may apply for Protection Orders to the local District Court Clerk and this process eventually progresses to a Barring Order, which effectively prohibits the spouse entering the family home. Those later orders only apply to married couples. Common Law relationships are not afforded protection under the Protection of Spouses and Children Act and must therefore resort to civil remedy.

The Gardai wish to stress that any victim who requires advice on family law matters will be afforded same in the strictest confidence.

**Halloween:**

We ask all parents to ensure that they know the whereabouts of their children (small and not so small) on Hallowe'en night. Unfortunately many people suffer at the hands of pranksters and some of the supposed to be jokes have unfortunate consequences. Fireworks and bangers are illegal and dangerous. We encourage parents to organise events and ensure that they are properly supervised and thus play your part in minimising annoyance. The Gardai expect that all nocturnal activities (including bonfires) terminate at a reasonable hour, but certainly not later than 10pm.. We appeal for your support and co-operation.

Thank you

*Your Friendly Local Gardai*

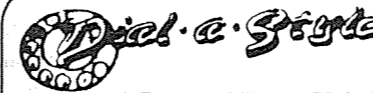

Tel. 628 5367

A Personal Home Hair Styling Service

Tired of Waiting at the Hairdressers?  
Problems getting a babysitter while you have your hair done?

Like your own personal stylist?

Have your hair styled by an experienced stylist in the comfort of your own home at a time that suits you best. Late appointments can be made for Wednesday & Friday  
Special Family Rates: Trim & Blow Dry for Mum, Dad and four children - £12.00

DIAL-A-STYLE at 628 5367 FOR YOUR APPOINTMENT

**THE SHOP**

Main Street, Maynooth. Tel. 628 9683

Opening Hours:

8 a.m. - 8 p.m. Mon. - Sat.  
Sun. 8.30 a.m. - 2.30 p.m.

General Groceries • Newsagents  
Rehab Lotto Tickets  
Stationery • Greeting Cards  
Wrapping Paper

24 Hour Photo Developing Service

**GARDENING HINTS**

**Flower Garden**

This is the best time to plant roses, trees, herbaceous plants and shrubs. Continue to plant bulbs in beds and borders. Take up dahlias when cut down by frost. Plant crowns of lily-of-the-valley. Divide herbaceous plants and rearrange borders.

Patio containers and tubs should finally be cleared of the summer leftovers. If you're looking for something to put in your containers a popular plant for this winter is the ornamental cabbage and when planted in the centre of a tub or container and surrounded by winter pansies, can look very interesting and colourful.

In order to protect herbaceous plants from frost, cover them with a blanket of straw, bracken or peat. Put a sheet of glass, supported on two bricks, over alpine plants that suffer from winter damp. Apple and pear trees should be pruned once they have lost their leaves.

Remove as much debris from the garden as possible - leaves and anything that could harbour garden pests during cold weather.

**Lawn Order - Mowers away**

The lawn should have received its final cut for the winter and mowers put away for winter storage. Find a dry place and put the machine on a raised board to keep it off the ground. Before putting the machine away for storage, petrol and oil should be drained and the sparking plug should be removed and cleaned and fine oil sprayed in the cavity before replacing. With regard to hand mowers, these should be thoroughly cleaned and metal surfaces should be wiped over with a well soaked oily rag. Check all nuts and bolts; replace worn ones and tighten those that are loose. If your mower needs a professional service, now is the time to organise it - don't leave it until spring.

**Vegetable Garden**

Plant rhubarb. Lift parsnips after frost. Draw out a rough plan of present crops and arrange next season's in rotation. Cover rhubarb and scakale with straw manure. Plant fruit trees.

**Wildlife in the Garden**

To encourage birds such as blackbirds into your garden, leave windfalls on the ground for the birds to feed on. Set up bird feeding tables and hang peanuts in containers for blue tits and sparrows. If you want to continue feeding bluetits etc. until their young arrive, peanuts can be bought in large quantities in most garden centres and these work out much cheaper than buying in small quantities in say, supermarkets. Remember to hang containers and to place feeding tables away from bushes and trees to prevent the local cat population using your garden as the local take-away.



## Features

### JOE DOLAN AT THE SETANTA 9TH OCTOBER 1993

This show should be called **THE JOE DOLAN EXPERIENCE**. J. D. and his eight piece backing band hadn't got beyond the opening three words of 'Good Lookin' Woman' (When God Created...), when the fans were on their feet and that's where they stayed, with 'More And More And More' throughout the show eventually ascending chairs, tables and the stage. At times it resembled a Charismatic Renewal Conference, especially when a 'Mexican Wave' of cigarette lighters went into action for J. D.'s second rendition of 'Jenny'.

J. D. gave the same honest value as when he and 'The Drifters' played marquee dances at carnivals in the Midlands thirty years ago. The laughing eyes and disarming smile alone would have kept Margaret Thatcher spellbound for the best part of two hours. The voice is still the winner. 'Unchained Melody' confirmed that J. D. can still hit and hold the high 'C's', while 'Pearl's A Singer' would have had Elkie Brooks queuing for his autograph. Can Ireland survive without Joe Dolan?

He's as much a sociological phenomenon as a music/entertainment one, and a worthy study for a University Thesis. The fans voted with their money, packed the Setanta an hour before J.D. appeared on stage, and ranged from grandparents to grandchildren.

Apart from the forthcoming Miss Royal Canal at the Setanta on November 18th, it was the best value for money in 1993.

*Declan O'Connor*

### LISDOON, LISDOON, LISDOON, LISDOONVARNA

The first weekend in October just gone saw a large group of Maynooth Community Council and *Newsletter* staff, including ex staff, packing their bags and heading for Lisdoonvarna. No tent or ground sheet rolled up tight here. For us it was to be the luxury of a beautiful hotel overlooking Galway Bay.

#### Our Mission

To support the Maynooth Bachelor of the Year, Eugene Fitzpatrick, was supposed to be our main reason for this trip. Alas we deviated somewhat. The demon drink took over and as a result at least a third of our group missed the main event. We drank, we ate and we danced and even I, with very little hair on my head, let my hair down.

#### Procedure of Elimination

Those of us who remained sober were very disappointed with the procedure of elimination of the competitors. Behind closed doors four adjudicators sitting like a board of enquiry interviewed twenty six hopefuls. For some this was too much and as a result many supporters of the twenty six competitors who had travelled from all over the country were extremely disappointed not to see their bachelor in action.

#### Nine Finalists

From nine o'clock Saturday night to 3 o'clock Sunday morning supporters were left waiting whilst the "board" sat. Eventually, from behind closed doors emerged the four "judges" with their "verdict". The M.C. interviewed, before the large gathering in the Hydro Hotel, the final hopefuls. Eventually Tommy McGrath from Tipperary was chosen the All Ireland Bachelor of the Year. Most agreed he was an excellent choice and there is no sour grapes when we say that had our own Bachelor of the Year, Eugene, been given a chance to display his talents before this gathering, the results, we have no doubt, might have been a lot different.

### NEW ITALIAN RESTAURANT

Maynooth saw the opening of a new restaurant, specialising in Italian cuisine on Saturday 16th October. "Donatellos" is situated in the Town Centre Mall and has all the potential of a very successful venture.

The owner and chief chef, "Antonio", is a fourth generation pizza chef so, needless to say, pizza is one of the choices offered on the menu.

The restaurant is open from 12 till 3 for lunch and from 6 till late for dinner. An average lunch at Donatello's costs about £3.99 e.g. pizza or lasagne with side salad or garlic bread. Dinner prices vary, the most expensive being steak with a choice of different Italian sauces and potatoes and veg. This comes at a very tasty price of £8.50. Sunday lunch is also available from 12 till 3 with a very reasonable children's menu.

To set the scene for a romantic evening, the restaurant is candlelit, with soft Italian music playing in the background. All of this, combined with a glass of wine from the wine list creates an ambiance of a continental nature.

## Jim's Shoe Repairs

Maynooth Shopping Centre

Ladies & Gents Heels While U Wait  
Shoes Stretched • Heels Lowered  
Gents Leather Soles Stitched On



Key Cutting Service  
Now Available



Now Located End Unit  
Opposite Rear Car Park Entrance

## Features

### NEW SCIENCE BLOCK LAUNCH

The opening of the new Science Block in St. Patrick's College, Maynooth, on September 28th last proved to be one of enormous celebration and of great historic value. Due recognition was given to the important milestone by An Taoiseach, Mr. Albert Reynolds, presiding at the official opening ceremony. "Eighteen months ago I was here to lay the foundation stone for this great facility, and now it gives me tremendous pleasure to be here to preside at its opening." The College has won great international admiration for the important work it has done in the scientific field for a number of years.

The new £7.3m. Callan Science Building, financed with E.C. structural funds, was blessed by Cardinal Cahal B. Daly immediately after the opening. The building is named after Rev. Professor Nicholas Callan, who invented the induction coil at Maynooth in the early 19th century and patented the Maynooth battery.

The foundations for the building were laid on 24th June, 1992. It is the first purpose-built science building to open in the college's 200th anniversary year. It will accommodate 730 students, 280 in computer science and 450 in biology, at all levels, ranging from first year undergraduates to doctoral level. The building will have an educational infrastructure which will have the facilities to produce young graduates so well trained as to become critical elements in Ireland's industrial development. It will also provide key facilities for advanced research programmes in its designated laboratories whilst facilitating the ongoing work of Dr. Tom Cotter and Professor Martin Downes in their development of a suicide gene designed to destroy themselves and also cause cancer cells to die.

The two principal guests at the opening, An Taoiseach, Albert Reynolds, and Cardinal Cahal B. Daly were welcomed by Monsignor Miceál Ledwith, President of Maynooth College. Msgr. Ledwith spoke of the extensive development of the north campus, including a library, student apartments and restaurant and sports complex (incorporating the Student Union offices) completed in the last decade together with phase one of the Science Faculty and the construction of a new Students' Centre, which is currently under way.

With the College being one of the highest employers in Co. Kildare, this new development will be a great asset to the community.



L to R: John McLoughlin, An Taoiseach, Karen Cullen, Mary McMechan and Msgr. Ledwith.



Monsignor Ledwith and An Taoiseach Albert Reynolds at the Official Opening Ceremony

### NEWTOWN STORES EXTENSION

Newtown Stores in Beaufield Estate has recently extended its premises. The shop has been going from strength to strength under the management of Brian Connaughton.

The smaller shop on Greenfield Lane has been in existence for six years now. A year and a half ago Brian ventured towards the new shop units in Beaufield.

With the amount of new houses being built in the vicinity there is a great need for a good local supermarket. The extension allows for an expansion of stock including fresh meat and chickens, delicatessen and cooked meats, a greater selection of frozen goods, general grocery provisions, light hardware, toys and magazines.

This shop is really a great amenity for the residents of the surrounding estates. We wish them continued success.



L to R: Simon Curtis, Paul Byrne, Ailish Connaughton & Brian Connaughton

## Features

### MAYNOOTH PLANNING APPLICATIONS 6/8/93 TO 5/9/93

**Rockfield, Railpark, Celbridge Road, Maynooth**  
High Degree Construction c/o Horan Associates, 127 Phibsboro Road, Dublin 7 - erection of semi-detached houses on approved sites Nos 105-108 inclusive.

**Ryebank, Dublin Road, Maynooth**  
Brendan Glass c/o Eamonn McCann Arch. Coach House, Carton House, Maynooth - change of use of office annex to dental surgery.

**Straffan Road, Maynooth**  
Eso Ireland Ltd., Retail Engineering, Stillorgan, Co. Dublin - petrol filling station including canopy, pumps, ID sign, carwash, tanks, shop and ancillary works in substitution for filling station etc.

**Site 134, Rockfield, Railpark, Celbridge Road, Maynooth**  
McNamara Construction c/o Horan Associates, 127 Phibsboro Road, Dublin 7 - minor modifications to the roof of an approved detached house.

**Johninstown, Maynooth**  
John Hurley c/o David Cullivan B. Arch. 3 Grove House, Salem Ct., Maxwell Road, Dublin 6 - erect 1 no. dwelling house, garage, entrance gates and septic tank.

**Dublin Road, Maynooth**  
P. Fitzgerald & Company c/o Paul C. Mealy, Con. Arch., Main Street, Celbridge, Co. Kildare - Office Development.

**Silken Manor, Maynooth**  
North City Builders Ltd. c/o McManus Arch. Main Street, Maynooth - extended rear kitchen, new side window and door and minor structural amendments to houses 2, 3 and 4 already approved and retention of same to etc.

**80 Kingsbry, Maynooth**  
Peter Connolly, 80 Kingsbry, Maynooth - retention of roof light to my dwelling.

### REKINDLING THE PAST THROUGH A NAME

Keely's Corner is not just the name of a shop, it also carries rich historical significance for the people of Maynooth. The Keely name has been present for many generations in the town and the shop is located on the centre from where the Keely heritage developed. The Keely blood has been in the house since the 1850s when Thomas Keely and his wife Kate took ownership. The premises then fell into the hands of Laurence Keely their son who married Bridget Keely (nee Brazil). The daughters of the aforementioned Kathleen Landy (nee Keely), who now lives in Listowel and Margaret Bean (nee Keely), still resident in Maynooth, lived in the house as children. The house today is dwelt in by Breda Landy, Kathleen Landy's daughter. So the descendancy still lives on.

If you ask an old established local where Keely's Lane is they will point to the lane beside Keely's shop even though its real name is Coates Lane thus showing the significance of the Keely name through Maynooth's history. The corner was a

popular meeting place for the old men of Maynooth who either sat on the granite stone outside (which still exists today) or on the windowsill itself to catch up on the auld gossip ensuring they didn't miss a thing.

The shop was called "Presents 'n Mind" but this new name "Keely's Corner" in the words of the owner, Seán Horgan (who is engaged to Breda Landy) "incorporates the atmosphere of the corner back to older days".

### ROCK FEATURE - 'SCHIZOPHRENICS'

Young rock bands are springing up all over the place in Maynooth. One of the reasons for this is that so many young people learn to play a musical instrument (the main ones being guitar or piano) and end up grouping together to "gig".

One such group of young people formed a band called the "Schizophrenics".

The members are William Gannon ("Ganno") on drums from 20 Leinster Cottages, Vinny Nevin (base and vocals) from Barrroughstown, Cian O'Melia (guitar) from Cluain Aoibhinn, and last but not least Kevin Farrell (guitar) from Celbridge Road. The group has been together for three months now. Their main influences would be "Metallica", "Slayer", "Sperm Birds", "Therapy" and "Fugazi", of whom they would play a lot of covers. There are a few budding writers in the group and up to now they have written two songs. Their first song "Simon" was composed by Cian and the second is called "Prime Evil" with lyrics by Kevin. The latter is about being possessed and its effects (heavy stuff!!!).

At present they have three local gigs coming up in the next two months (dates not verified yet); one for the No Name Club official opening, another in Dunboynne's Community Centre and the third in the G.A.A.

However, they are interested in making a career out of their music and to do this you really need to break into the Dublin scene. In April, 1993, the older group before the present changes played in the Grattan in Dublin, a notable venue for rock bands. They had a great following from Maynooth which was great encouragement for the band.

### Rock Garden

A venue they are aiming to get into at present is the Rock Garden as many young bands are spotted by promoters here. Unfortunately, the snag with getting your foot in the door is that you have to produce a demo tape, which costs a fair amount of money to put together. However, the band are quite hopeful to reach this goal in the near future.

When you think that the band "Metallica" started their career in the Grattan, who knows in years to come we may be proud of our local band, the "Schizophrenics".  
If interested in booking the band for a gig just contact Kevin at 6272112.

If anyone would like to submit articles to this Rock Column or provide information about fixtures for future gigs, please forward to *Maynooth Newsletter* by 12th November for the next edition.

# Keely's Corner

## Main St. Maynooth

(formerly Presents 'N Mind)

Phone 01- 6286116

### Opening Hours

Monday - Saturday 9.00 a.m - 6.30 p.m.

- We have the best set of cards in town, constantly updating our range.
- Now in stock the ZANY "Far Side" Collection
- Look out for our New Stock of Candles + Accessories
- Decorative Wreaths and new line of Irish-made Pottery arriving shortly - Ideal Gifts

### A Deposit Secures Any Article

## Why Not Order Your Christmas Wreath Now

### We also sell

## Sweets, Cold Drinks, Cigarettes, Blank Tapes, Batteries and Newspapers

### Licensed To Sell Stamps + Call Cards

### JOIN THE TROLL FAN CLUB NOW

We would like to thank you for your custom over the past year and to show our appreciation you will be entered into a draw for any purchase over £5.  
Draw takes place on the 30th November.

## Features

### THE TERRY FOX RUN

The Terry Fox Run went ahead as planned on Sunday 17th October. Emmet Stagg T.D. opened the event as 50 people ran, walked and cycled along the route.

This event, which is in aid of Cancer Research was run for the first time in Ireland this year in towns all over the country and should now become an annual event.

All of the participants received a certificate at the end of the Run. The first man to arrive back was Dara Clear and the first woman was Sharon Harte.

Many thanks go to the organisers Carmel O'Dea and Patricia Moynan, helped by John Mc Ginley, Cian Mc Ginley, Leo Armstrong and Ann Touhy to name but a few. Also thanks to Orla Travers who organised people from Celbridge to take part and to Denis Clohessy and Joe Donnelly of the Maynooth College Students' Union. A special thanks goes to Paul Davis, Sports Instructor, also of the Students' Union.

Many thanks also to all of the participants and sponsors for a job well done.



Patricia Moynan and Carmel O'Dea with Emmet Stagg

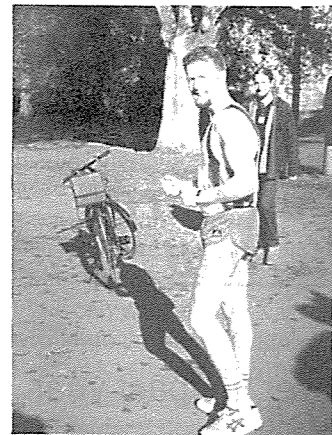

Dara Clear warming up for the Run

### TRAVELLING THEATRE GROUP

Presentation Convent was the venue for the show, attended by all students, split into two groups, one for juniors and one for seniors. We looked into the second show, the children were all

gathered in anticipation. It was educational in its content, - environment, ozone, and protection of wildlife were all covered in presentation.

Audience participation was also part of the act and the children really enjoyed this. The show was a great success and was enjoyed by all.

## MULLIGANS

GARDEN SHEDS KILCOCK

Telephone: 628 7397

Top Quality Sheds Available from £159

Also Super Lap Fencing Panels

6' x 6' £12.50

All types of Fencing  
& Timber Supplied

### COMPLETE ACCOUNTANCY SERVICE AVAILABLE

No Assignment too Big or too Small

Personal Attention of Qualified Accountant  
VAT • PAYE • Ledgers • Costing  
Stock Control • Annual Accounts • Returns  
Cash Flow • Budgets etc.

Contact:

**MICHAEL GLEESON, FCMA**

5 Straffan Way, Maynooth. Tel. 628 5246

### T. MENTON & SONS

Phone: 624 4857

**LEIXLIP CLEANING SERVICE**  
ALL SERVICES UNDER ONE ROOF

CHIMNEY CLEANING AT ITS BEST,  
BRUSH & VAC

PAINTING & DECORATING  
INTERIOR & EXTERIOR  
GUTTERS CLEANED & REPAIRED

YOU HAVE TRIED THE REST NOW  
USE THE BEST



## Children's Corner



**CODE BUSTER** - Each symbol represents a letter in the Alphabet.

Use the code to read the sentence.

A B C D E F G H I J K L M

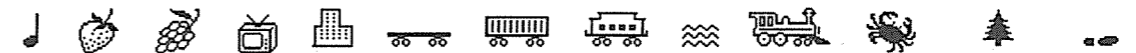

N O P Q R S T U V W X Y Z



Connect  
the dots

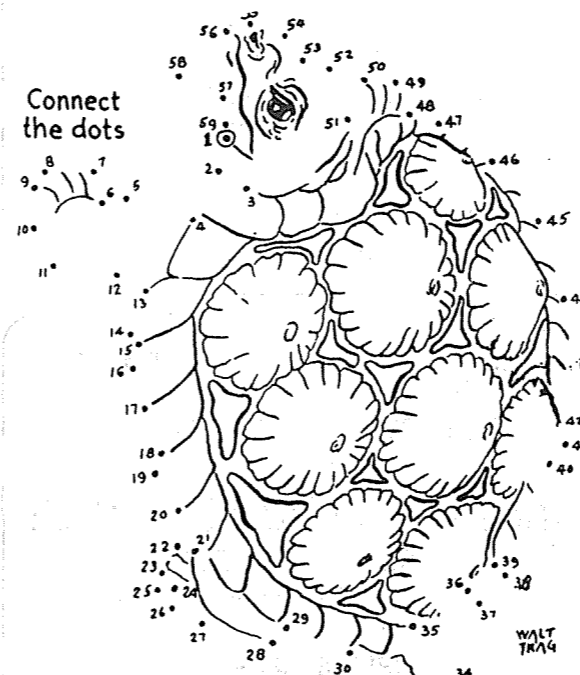

Monsters of the past  
Proganochelys (PRO-gan-O-kee-lis)

Connect the dots  
Monsters of the Past  
Iguanodon  
(ig-WAN-o-don)

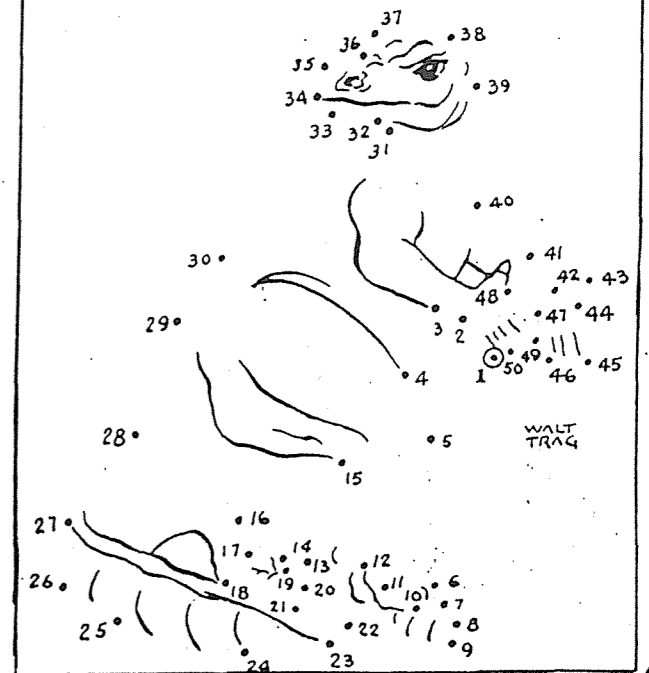

**MAYNOOTH G.A.A. NOTES**

**Juveniles Hurling**

After great performances during the Summer in which U/12 were beaten by a point by Broadford in the Bord na nOg Final, Primary School U/12 beaten in a replay by Monasterevin and U/10 finishing Runners Up in North Kildare League we were expecting big things when North Kildare Autumn League started. However, for various reasons many of the teams have been short and we are still waiting for our first victory at U/10, 11,12 having lost to Leixlip and Celbridge to date.

Juvenile Training is every Saturday at Salesians at 10.30 a.m. Anybody requiring lifts are to be at Greenfield Shops at 10.15 a.m. Hurlays and helmets are available at subsidised rates.

There will be some training sessions on Thursdays also and notice of these will be given in school.

**1st Team Results**

**1. Tom Flood Cup**  
Maynooth 12 pts Sallins 5 pts

Scorers: Paul Garvey 5 pts; Joey Edwards 3 pts; Mick Nevin, Ken Killoran, Joey Nevin, and Pascal Ennis, 1 pt. each.

Best: Conway, Noone, Burke, Mahony, Molloy, M. Nevin, Killoran and Joey Nevin..

**2. Tom Flood Cup Semi Final**  
Cappagh 3.8 Maynooth 1.9

Scorers: M. Nevin 1 goal; Ennis and Edwards 2 pts each; Joey Nevin, Johnny Nevin, Liam O'Toole, Joey Riordan and Ken Killoran, 1 pt each.

After struggling to dispose of a very young Sallins side in the Quarter Final Maynooth were bundled unceremoniously out of their own Tournament by a fresh and eager Cappagh side who fully deserved their victory. Cappagh seemed to have a greater appetite for the contest and hunted in packs never giving Maynooth a chance to develop their normal game. Maynooth contributed to their own downfall by making too many basic mistakes in a game which was played in the most miserable conditions of wind and rain.

**3. Confey Tournament Semi-Final**  
Maynooth 2.17 St. Mary's Leixlip 2.4

A welcome return to form by the team who although missing quite a number of players turned in a very impressive display to totally out-gun St. Mary's. Maynooth were on top from start to finish with the forwards in particular displaying a refreshing appetite for work. Some of the scores taken were "from the top drawer" with Hugh Purcell, John Nolan, Seanie Molloy, Joey Riordan, Liam O'Toole and Joey Edwards all getting in on the act. Maynooth were well served in other areas of the field as well however, with Burke complementing Fagan very nicely at mid-field and Ennis, Stynes and Mahony forming an impregnable half back line. Mick Nevin restored to his "favourite position at No. 3" was soundness personified and got very capable back-up from his flankers Conway and

Noone. Faherty was as alert as usual behind them and certainly could not be faulted for the goals. In addition all 3 subs used i.e. Mick Faherty, Mick Madden and John O'Toole acquitted themselves well when introduced. The net result...major headaches for the Selectors!

Scorers: Edwards 1.4; Purcell 1.2; Riordan 3 pts; Molloy 2 pts; O'Toole 2 pts, Nolan, Fagan, Mahony and Burke 1 pt each.

**Minor 'B' Hurling Championship Final**

On a damp and overcast Autumn morning Maynooth bridged a 28 year gap to bring the Minor Hurling 'B' Championship back to Maynooth. Our last win in this grade was back in 1965. From Goalkeeper to No. 15 Maynooth showed great spirit and determination. The six backs played to their full potential and led by their Captain at No. 6 Paraic Ward. Maynooth led at half time by 2 pts to nil. On re-start of second half Maynooth got on top and with two fine goals by P. Farrell, and V. Nevin and some lovely points by S. Brennan went on to a famous victory. This by all standards was a great team performance. Maynooth Scorers, S. Brennan 4 pts; P. Farrell 1 goal, V. Nevin 1 goal, M. Nugent 1 pt, P. Leahy 1 pt, also to play well were P. Ward, S. Noonan, E. Hassett, T. Farrell, S. Brennan, C. Ryan.

**Minor Football League**

Maynooth 1.7; Carbury 2.12

Carbury had a good win over Maynooth in this Minor League match. Carbury were the better team on the day. Maynooth tried hard but scores were hard to come by as Carbury had a very good defence. Best for Maynooth, K. Killoran, S. Noonan, P. Garvey, E. Mitchell, J. Sullivan.

Lotto Result - 19/9/'93 - Jackpot £770 - Numbers - 6, 7, 8, 20  
No winner - 5 X £10 - B. Barton, D. O'Driscoll, T. Farrelly, K. McDermot, M. Connolly.

Lotto Result - 26/9/'93 - Jackpot £830 - Numbers - 1, 3, 18, 20  
No winner - 5 X £10 - B. Curtis, Jude Donnery, Tereas Long, D. Doolan, S. Darcy.

Lotto Result - 3/10/'93 - Jackpot £888 - Numbers 2, 6, 22, 24  
No winner - 5 X £10 - Joan Carroll, Bernie O'Mara, Shay Tyrell, Martin Armstrong, Teresa Long.

Lotto Result - 10/10/'93 - Jackpot £950 - Numbers - 5, 13, 14, 17  
No winner - 5 X £10 - David Corcoran, Caroline Brady, Billy Nash, Ollie and Shay, Paddy Feely.

**Junior Football League, Semi-Final Maynooth 1.4; Leixlip 1.5**

In this replay of Junior Football League Semi-Final played in Rathcoffey. Maynooth had every chance of reaching the Final but for some very bad shooting. This game could have been won twice over if our forwards had taken their scores. Our Backs played very well and held Leixlip to a half-time score of Leixlip 4 pts., Maynooth 2 pts. On re-start of second half Maynooth went ahead by a good goal from R. Quinn. At this stage Maynooth were on top but scores were hard to come by then Leixlip broke up field and got their goal. Maynooth came back but could not get a point to make it another draw. Best for Maynooth:- D. Murray 4 pts., R. Quinn 1 goal, E. Dunne, M. Noonan, D. Cusker, E. Lyons, D. Fleming, M. Donnelly, T. Fay, M. Gahan.

continued



Extra copies of this page are available in the Community Council Office.

NAME \_\_\_\_\_ AGE \_\_\_\_\_

ADDRESS \_\_\_\_\_

**ALL ENTRIES MUST BE ORIGINAL WORK OF ENTRANTS.**  
This category of the colouring competition is for 4 - 12 year olds.  
Closing Date for receipt of entries is Friday 12th November 1993 by 5pm

**U/14 Football League Semi-Final Maynooth 4.8; Carbury 2.5**  
 Maynooth U/14 Team had a good win over Carbury in this U/14 League Semi-Final. From the start Maynooth got on top and by half-time had a good lead. The second half saw Carbury fight back but could not overcome a very good Maynooth defence. Maynooth took their chances and ran out easy winners. Best for Maynooth, D. Coughlan, E. Gallagher, C. Lyons, A. Nugent, V. Nevin, M. Byrne, P. Ryan.

**U/16 Hurling League Final - Maynooth 4.2 V Eire Og-Corrachoil 3.4**

As previous week our Minor Hurlers brought a Hurling Title to Maynooth, our U/16 Hurlers bridged a 30 year gap. The last U/16 Hurling title came to Maynooth in 1963. The match V Eire Og-Corrachoil our U/16 Hurlers virtually pulled themselves back from the dead. A heavy pitch at Celbridge venue coupled with a constant mist, made a murky setting for the Final. Eire Og-Corrachoil side dominated the opening half. Maynooth's only score of the half was a point by Stephen Brennan. However, Maynooth held firm and by half-time were behind by 3.1 to 1 pt. Maynooth started the second half with a neat goal by Vincent Nevin but Eire Og-Corrachoil fought back and with 10 minutes to go were 8 pts. ahead then the hard working Michael Bennett found the Eire Og-Corrachoil net 3 times and Cathal Ryan fired over the safest score in injury time. The final whistle sounded to Maynooth's jubilation. The come-back was complete. Best for Maynooth were David Moore, Ronan Murphy, Stephen Brennan, Joe Rossiter, Alan Gaffney and hero, Michael Bennett. Maynooth Team who brought this title back to Maynooth:- J. Moran, D. Buckley, D. Moore, E. Nevin, S. Griffin (Capt.), R. Murphy, M. Bennett 3 goals, S. Brennan 1 pt, M. Nugent, C. Ryan 1 pt., J. Rossiter, R. Casey, J. O'Shea, V. Nevin 1 goal, A. Gaffney, G. Lyons, E. Heslin, S. Cummins, R. Kelly.

**1st Team  
 Hugo Lyons Cup Final, Confey**

**Maynooth 1.10; Garda 10 pts.**  
 After a facile victory over St. Mary's Leixlip in the semi final Maynooth met more resolute opposition in the final in the shape of a well balanced Garda side and emerged worthy winners after an hour of hard fought football. Exchanges were keenly contested all through with Maynooth finding it difficult to "put any daylight" between themselves and Garda.

The scores were level at half time - a half the highlight of which was Hugh Purcell's goal. A super solo effort by Purcell who having gained possession 30 yards out rounded his man and hammered the ball to the net. In the second half Maynooth went ahead on a number of occasions but were hauled back by Garda. It was only in the final 10 minutes that Maynooth got the decisive scores through Johnny Nevin, Joey Nevin and Hugh Purcell.

After the game the Hugo Lyons Trophy was presented to the winning captain Joey Edwards by the chairman of the Confey Club.

Scorers: Hugh Purcell 1.2, Joey Nevin 3pts, Joey Riordan 2pts, Liam O'Toole, Killian Fagan and Johnny Nevin 1 point each.

Best: Aidan Burke, Mickey Noone, Pascal Ennis, Paul Stynes, David Mahony, Killian Fagan, Joey Nevin, Liam O'Toole and Hugh Purcell.

**Historic U/14 Football Victory**  
 After a long and arduous campaign which began last April the Maynooth U/14's finally tasted autumn glory. It was no more than these thirty-two dedicated followers of the Gaelic code deserved. After a gruelling twenty-four training sessions and nine or ten friendly matches, the management team of Mick Gillick, Mick Meally and Manus McCarron felt they had a settled side which would outplay anyone in Kildare.

**The Road to The Final**  
 In late August Maynooth played the last of their fixtures against Round Towers. In this match Maynooth showed their fighting spirit, determination and guts. In the second half Round Towers mounted wave after wave of attack on the Maynooth goal. The backs stood firm and repelled every attempt to breach their defence. None more so than Man of the Match Eamon Gallagher. This match helped us to settle on our best fifteen and where to play them. This victory put us through to the semi final against Carbury.

**9-10-93  
 Maynooth 6-9 Carbury 2-3**  
 This match was played in St. Kevin's ground in Staplestown. Carbury were the only team to have beaten us in the league so they fancied their chances. However they hadn't taken the skill and commitment of Maynooth into account. In the first half Maynooth put on a power display of football and led by 2.6 to no score at half time. Carbury rallied and put some good moves together in the second half. Maynooth conceded a penalty midway through the half. This however didn't dampen their spirits and they got some lovely scores in the second half especially a lovely goal by Jonathan Mee and a goal that was chipped over the keepers' head by Darren Naughton which would grace any football field at any level. The training and hard work was paying off. Maynooth U/14's had come of age with a skilful and intelligent display of football.

**The Final**  
**17/10/93  
 Maynooth 3.7 Celbridge 1.3**  
 The final was played in Sallins on a beautiful sunny Sunday in October. The sun shone all the way for Maynooth as in front of huge support, they battled hard and overcame first half nerves, to run out comfortable winners in the end. Celbridge played a physical game and unsettled us in the first half. We opened the scoring with two nice points but fluffed many good chances. Celbridge wingers Simon Roach and Garrett King opened Maynooth up on the right wing. One of these attacks resulted in a goal which Packie Carroll saved initially but the rebound was sent to the net by Garrett King. Maynooth battled away nervously and were leading at half time by 0-5 to 1-1. In the second half Maynooth settled and set about their task of dismantling the Celbridge defence in workmanlike fashion. Marty Byrne came into his own and had an outstanding second half. Early on he laid a ball off to Niall Naughton who set up John O'Shea who coolly placed the ball beyond Darren Short in the top right hand corner of the net. This was a peach of a

**KEANE WINDOWS LTD.**

**45 BEECH PARK, LUCAN CO. DUBLIN.  
 TEL : 6280445 FAX : 6280445**



**uPVC / ALUMINIUM • PATIO DOORS  
 WINDOWS • PORCHES  
 DOORS • CONSERVATORIES**

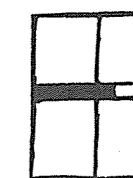
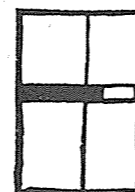

**SINGLE / DOUBLE GLAZING  
 MANUFACTURED IN uPVC /ALUMINIUM  
 AND AVAILABLE TO YOU  
 IN EITHER WHITE, BRONZE OR WOODGRAIN FINISH**

**CONTACT US FOR YOUR QUOTATION**

**CPL MOTOR FACTORS**

**MAIN STREET, MAYNOOTH, CO. KILDARE.  
 TEL: (01) 6286628/6286301**



**PARTS AND ACCESSORIES FOR ALL MAKES OF CARS,  
 TRUCKS AND TRACTORS.  
 BATTERIES, PLUGS, EXHAUSTS & BRAKE PADS.**

**Libert Reilly**

**PROSPEROUS, NAAS, CO. KILDARE. 045/68230 - 045/68482  
 Undertakers and Complete Funeral Furnishers  
 WREATHS HEADSTONES MOURNING COACHES**



**New Funeral Parlour at Town Centre Mall, Maynooth  
 Undertakers to Maynooth Mortality Society  
 (Funeral Parlour free to Society Members)**

**Particulars and Arrangements Contact:  
 Paddy Nolan (Sec), 41 Greenfield Drive Phone 6286312  
 Kevin Murphy, O'Neill Park Phone 6286399**

goal and would certainly be in the running in any goal of the season competition anywhere. This immediately settled our team and reminded them that they were the best team on the field. So often in the past Maynooth teams have not played up to their potential especially in finals. This didn't happen to this team. With Niall Byrne, Eamon Gallagher, David Coughlan and Conor Lyons dominating the backs, Vinny Nevin controlling a very dangerous Damien Brennan in the middle of the field the forwards got the supply of ball they relish. Niall Naughton and John O'Shea combined very well on the left wing and Darren Naughton and Adrian Boylan combining on the right the Celbridge goal was constantly under pressure. Marty Byrne ran through to smack a great ball to the roof of the net and Pearse Ryan taking another great goal the match went beyond recall for Celbridge. Still they battled bravely on and Damien Brennan at number eight never gave up and took a few nice points towards the end. Maynooth finished the stronger and more skilful team and ran out comfortable winners in the end. This was an historic victory. It was the first time Maynooth has won the Division 2 U/14 League/Championship. We had won the Division III League/Championship five or six years ago. The team won because of hard work, commitment and most of all, discipline. Who says nice guys finish last? One player who got us to the final but missed out because of injury was Matthew Callaghan. It was nice to see him at the final and on the mend. The victory was greeted very enthusiastically by the large attendance from Maynooth. The noisy victory cavalcade of over fifty cars was led by Seamus Nevin's pick-up with the team perched precariously on the back.

Scorers: Marty Byrne 1-2, John O'Shea 1-2, Pearse Ryan 1-0, Niall Naughton 0-2, Darren Naughton 0-1.

Best for Maynooth: Eamon Gallagher, Niall Byrne, David Coughlan, Conor Lyons, Vinny Nevin, Marty Byrne, Niall Naughton, John O'Shea, Alan Nugent.

Man of the Match: We felt it was truly a team effort with everyone playing their part and were unable to separate any of the above named players for the award of Man of the Match.

**OUR ANNUAL DINNER DANCE WILL BE HELD ON FRIDAY, 10TH DECEMBER, IN CLUB HOUSE.**



Davie Dennis presenting the Minor Cup to Maynooth Captain, Paraic Ward

**MAYNOOTH TOWN A.F.C.**

**Leinster Junior Cup**  
**Maynooth Town 2 Killenagh Wdrs. (Wexford) 3**

Killenagh Wdrs. made the long trip up to Maynooth for this first round tie and were rewarded with their passage into the second round. Subsequent results have seen them advance to the fourth round. Our disappointment at being beaten so early is now tempered somewhat by the knowledge that our conquerors have made steady progress in the competition.

The game itself was a typical cup-tie which developed into a tough hard slog throughout the ninety minutes. But Maynooth were never able to assume command at any stage of the game. Killenagh went in front midway through the second half. Maynooth fought back to equalise when John Geoghegan's corner was headed home by John O'Neill. Two goals in the opening minutes of the second half by Killenagh proved a large obstacle for Maynooth to overcome and a Gerry Quinn goal was not enough to inspire us to victory.

**Watkins Cup**  
**Maynooth Town 6 Jobstown Celtic 1**

Maynooth put the disappointment of the previous week to the back of their minds and attacked Jobstown right from the start. This was sweet revenge for Maynooth having been narrowly defeated by the same opposition in an early season league game. The opening goal came in the third minute when Joe O'Riordan scored following a Ger Thompson pass. Joe O'Riordan made the second goal for Philip Doyle after an accurate cross into the penalty. John Geoghegan scored the third from a penalty after Joe O'Riordan was taken down. Maynooth were now totally dominant and two further goals by Joe O'Riordan to complete his hat-trick plus a goal by Gerry Quinn made up this impressive Maynooth scoreline.

**F.A.I. Junior Cup**  
**Foxhill Utd. 1 Maynooth Town 3**

Joe O'Riordan was in top form once more and grabbed his second hat-trick in two weeks when we had to come from behind to topple the Athy side. Conditions were dreadful for this game and the hospitality shown after the game by the home club was savoured with great relish. This win also avenged a defeat in this cup a few years ago when Foxhill visited Maynooth. Philip Doyle laid on the first goal just before half-time for O'Riordan to open his account and he scored his second goal seven minutes into the second half when converting a John Geoghegan corner. Fergal Barton provided an accurate cross for Joe O'Riordan to complete his hat-trick in the 68th minute.

**Leinster Junior League Division 1**  
**Cathal Brugha Rgs. 3 Maynooth Town 2**

The concession of three goals to strong opposition such as Cathal Brugha proved too big a hill to climb but the fighting spirit shown in the second half compensated somewhat for our early indecision. John O'Neill gave us a glimmer of hope when he scored, following a mix-up in Cathal Brugha penalty area. Maynooth kept up the tempo and Joey Dempsey gave us

continued

# DONOVAN'S

## Greenfield and Maynooth Shopping Centre

*Largest Selection of Greeting Cards in town*

- Fine Art Graphics : Cara Irish
- Simon Elvin : Goldcrest Irish
- Forget Me Not : Misty Wood
- Tender Thoughts : Light Lines
- Route One : Academy
- Flowers : Name Cards
- Irish Cancer
- Wedding Day Ribbons : Confetti
- 21st Keepsakes
- Birthday Banners : Balloons
- Teddys : Party Novelties
- Christening Candles

-----

*See our new enlarged Magazine Sections*  
**Lottery \* Call Cards \* Films \* Sandwiches**

## Sports News

further hope with a second goal. But time ran out with Cathal Brugha pinned in their own penalty area. Enda Carr and Joey Dempsey were excellent in this narrow defeat.

### Leinster Junior League Division 3 Private Grds. Maynooth Town 4 Ranelagh Celtic 2

Maynooth conceded a penalty in the opening minutes but some gritty play brought us right back into the game but a missed penalty left us trailing against the run of play. Robert Thompson brought us level from the spot and put us in front shortly after with his second penalty. Michael Murphy provided John Murray with a pass to score the best goal of the game and the same player sealed victory with his second goal following a solo effort. John Murray, Derek Dolan and Johnny Thompson were best for Maynooth.

### Leinster Junior Shield Maynooth Town 9 Gorey Rgs 1

This was the most comprehensive result for our second team this season and was rich reward for their all out attacking play. This all out attack was instrumental in us falling behind in the first few minutes when we were caught out in defence. This setback only spurred us on and from the moment Michael Murphy got the home equaliser it was all one way traffic as Maynooth went on a scoring spree. Killian Fagan proved Maynooth's star when helping himself to four goals. Michael Kelly, Nicky Farrell, Mick Faherty and Robert Thompson added a goal apiece to seal a memorable victory. Best for Maynooth were Killian Fagan, Darren Moran and Michael Murphy.

### Division 3 Private Grds. Maynooth Town 2 Cuffe Celtic 2

Maynooth took a long time to settle in this game against an impressive Cuffe Celtic side and paid the penalty by conceding two goals in the first half. Maynooth missed a number of good scoring chances before eventually opening their account. John Murray was about to score when taken down in the box and Robert Thompson duly converted the spot-kick. Maynooth were unlucky not to be awarded a second penalty but the referee waved away the confident appeals. Maynooth finally got on terms when Michael Murphy's corner was powerfully headed home by Killian Fagan with fifteen minutes remaining. Maynooth tried valiantly to grab a winning goal but were beaten by time.

### D.D.S.L. U15 League Maynooth Town 2 Sandyford 2

A draw was a fair result to this game where Maynooth had to battle back from two goals down to earn a deserved draw. Maynooth lacked their usual composure in the early part of the game but improved as the game progressed. Donncha McCarrick and Martin Byrne got the all important goals in a game where Eoin Guha and Donncha McCarrick were in top form.

### U/13 League Maynooth Town 0 Tymon Bawn 4

The much bigger Tymon Bawn side carried too many big guns for our side who battled hard but were unable to overcome the

greater physical strength of the Tallaght side. Peter Kinsella and David Dolan battled hard in Maynooth's cause but to no avail.

### U/12 League Benmadigan Utd. 2 Maynooth Town 0

Lack of scoring power cost us dearly in this defeat by a very stylish and workmanlike Benmadigan Utd. side. Good mid-field play by Maynooth was wasted when a number of good scoring chances were not availed of. Andy Madden toiled away in his usual tireless manner but was unable to inspire his colleagues to raise their game sufficiently to achieve victory.

### U/10 League Maynooth Town 3 St. John Bosco 3

We looked to be in for a heavy defeat in this game when falling two goals behind in the first fifteen minutes. Simon Fagan and Joe Fleming were architects of a thrilling fight back and goals by those two players plus one from Thomas McGovern put us into a 3-2 lead but a late St. John Bosco goal spoiled the Maynooth celebrations. This was a good performance by Maynooth and maintained their recent good form.

### U/12 League Maynooth Town 7 Ashbourne Utd. 1

Maynooth completely over ran Ashbourne who never got into the game at any time and suffered a heavy defeat. The floodgates opened after Sean Brady scored the opening goal and further strikes by Andy Madden (2) Trevor McMahon (2) Shane Folan (1) and a second Sean Brady goal completed the rout. Sean Brady, Darren Cusack and Paul Dunne played leading roles in this easy victory.

### U/10 League Usher Celtic 0 Maynooth Town 1

Maynooth played with great spirit and heart in this tough game and were good value for this close win. It looked as if a draw would be the final outcome, but, with time running out, Joe Fleming beat a number of Usher defenders to shoot to the roof of the net. Paul Farrelly and Martin Conway were sound all through for Maynooth.

### U/15 League Maynooth Town 9 Grange Abbey Boys 2

Grange Abbey Boys had shown good early season form but were no match for Maynooth who gave a display of all out attacking football which paid rich dividends. Four goals by Francis Larkin, three from Eamon Gallagher and one each from Donncha McCarrick and Martin Byrne made up a scoreline which always looked on the cards following the opening Maynooth goal.

### U/10 League Lourdes Celtic 0 Maynooth Town 3

This was probably the best display of the season by our U/10 side who are in their debut league season. Goals by David Harper, Simon Fagan and Thomas McGovern made up this

## O'NEILLS AUTO ELECTRICAL

Dublin Road, Maynooth  
Tel: (01) 6286611

### STARTERS ALTERNATORS DYNAMOS

12 or 24 Volts

Repairs or Exchange Units

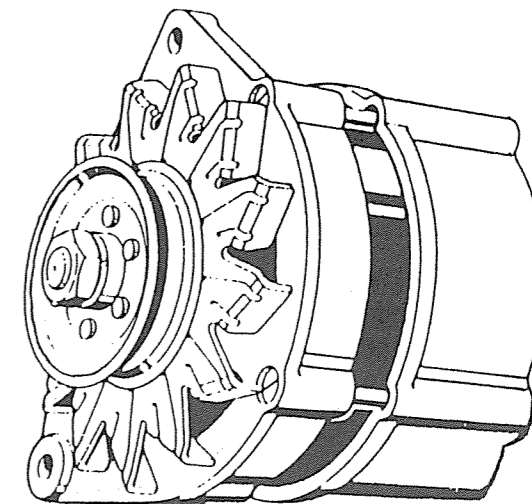

## Kennedy Woodcraft Ltd.

JOHNINSTOWN, MAYNOOTH.

TELEPHONE : (01) 6288086 FAX : 6270020

### KITCHEN AND BEDROOM UNITS

- Natural Oak
- Mahogany
- Pine
- Laminated Colours
- Textured Melamine

10a.m. until 8p.m. Monday to Friday  
10a.m. until 5p.m. Saturday  
(Quotation and Planning Service)

### WE CAN SUPPLY A COMPLETE RANGE OF

- Worktops
- Stainless Steel Sink Tops
- Wire Baskets
- Towel Rails
- Cutlery Insets
- Waste Bins
- Extractor Fans



## LITTLE ANGELS

Full Day Care Service  
Qualified Child Care Worker

• Toddler Group 1-2 years • Playgroup 2 1/2- 3 years •  
Mon - Fri 9.30am - 12.30pm Mon - Fri 10.00am - 1.00pm

Competitive Rates : Low ratios

OPENING HOURS: MON - FRI 7.30AM - 6.30PM  
Hot Meals Provided and Homely Atmosphere  
Fully insured



For further details contact: Karen - 50 Rockfield Court  
Tel: 6289588

very impressive scoreline in which Barry Coughlan and Ciaran McCullough were in commanding form.

The Club would like to thank Robert Cusack for his sponsorship of a full set of playing gear for one of our schoolboys teams.

**FULL ACCOUNTANCY SERVICE AVAILABLE**

INCLUDING  
 PAYE/PRSI • VAT • ACCOUNTS PREPARATION  
 SYSTEMS REVIEW & IMPLEMENTATION  
 COMPUTERISATION  
 FINANCIAL & TAXATION ADVICE

ALL ASSIGNMENTS UNDERTAKEN WITH ABSOLUTE  
 CONFIDENTIALITY GUARANTEED

FOR A FREE CONSULTATION WITH AN EXPERIENCED  
 PROFESSIONAL ACCOUNTANT PLEASE CONTACT  
**DAMIEN O'DOWD, B.Comm, F.C.A.**  
 TEL. 01 - 628 5432

**M.C.L. CABS LTD.**

YOUR LOCAL HACKNEY - CAB SERVICE

TEL. 01 - 628 6539 • 628 9222  
 MOBILE: 088 - 567878

NEW CELBRIDGE NUMBER: 01 - 627 0222  
 24 HOUR SERVICE

WEDDINGS • BUSINESS • SOCIAL  
 DISTANCE NO OBJECT - KEENEST RATES

MINI BUS \* EUGENE & COLETTE O'SHEA \* CABS

**MAYNOOTH 1994 BUSINESS DIRECTORY**

We are currently compiling our  
 triennial Directory of local business.  
*The Directory will be distributed free to all  
 households in Maynooth, early in the New Year*

Anyone wishing to place an Advertisement can call  
 into the Newsletter office or phone us  
 on **628 5922** or fax us on **628 5079**  
 The rates are as follows:  
**Full Page £50 • Half Page £25 • Quarter Page £15**

**MAYNOOTH FIANNA FAIL**

Maynooth Fianna Fáil cumann held its October meeting on 6th October. There was a large attendance.

Among the items discussed was the Hume-Adams initiative, on which a statement, praising the courage of John Hume, who has laid his political future on the line for the sake of a cessation of violence in the Six Counties.

Also discussed was the delay in the demolition of the Square, which we were assured back in April would have begun in early Autumn. It was decided to contact the County Council regarding this matter as soon as possible. We are awaiting a reply at time of the *Newsletter* going to print and hope to have resolved the matter by next month.

At the meeting, a sub-committee consisting of four members was formed to liaise with local public-interest groups with regard to highlighting and acting upon local issues. For more information on this sub-committee or if you have any queries on any item contained in this article please contact any of the people listed below (evenings):

Séan O Síothcháin 628-5777  
 Ruairí Newman 628-9189  
 Cyril McAree 628-5447.

*Ruairí Newman P. R. O.*

**FINE GAEL NOTES**

**Playing Fields for Maynooth**

In the April issue of this *Newsletter* we reported that Kildare Co. Council had adopted a motion, proposed by Bernard Durkan T.D. "that provision be made for more open spaces in future developments in the county". This motion was for inclusion in the revision of the Draft Development Plan.

It is, in the opinion of the Maynooth Branch of Fine Gael, scandalous that in a town with 1,500 Primary and Post-Primary pupils, no provision has been made for playing fields or sports facilities. As each open space in and around the town is developed, we are in danger of becoming a concrete jungle. We therefore call on Kildare Co. Council to acquire 50 acres of land, within easy reach of the town centre, for sports and recreation. This should be done before any further development is approved and should be included in the Draft Development Plan.

**Extra Space for Post Primary**

A new school year is underway and still nothing concrete has been heard from the Minister of Education on the provision of the much needed additional classrooms for the Post Primary School. For well over a year now, Bernard Durkan T.D. has been raising the matter with successive Ministers for Education without success. It is over six months since the present Minister visited the school to see the position for herself.

Though the Department of Education has indicated verbally that an extension will be approved nothing has been committed to writing on the type of extension being approved or a proposed commencement date. Besides the obvious problems

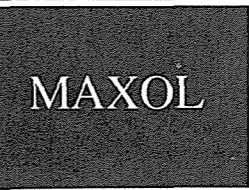

**DECLAN BROWNE**

**KILCOCK OIL DISTRIBUTORS LTD.**

**YOUR LOCAL MAXOL DISTRIBUTOR  
 WINTER GRADE**

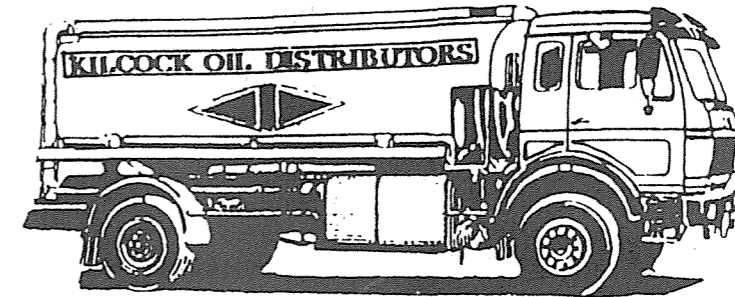

**FOR SERVICE, QUALITY AND VALUE INTO THE 90's  
 FOR DELIVERY  
 PLEASE PHONE 6287797 OR 6284071**

**Tiny Toes Creche**

**\* PLACES NOW AVAILABLE \***

**Toddler Group 1-2 years                      Playgroup 2 years upwards**  
**Services include : Full-time Day Nursery - "Drop-in" Creche - Playgroup**  
**FULL HOT MEALS**  
 (Safe Supervised Indoor and Outdoor Play Areas)

**Competitive Rates : Low Ratios**  
**\* Bright \* Open \* Homely Atmosphere \***  
**Individual Attention Guaranteed**

**Open Mon - Fri. 7.30a.m. - 6p.m**  
**Playschool 10.a.m. - 12.30p.m. Mon - Fri**

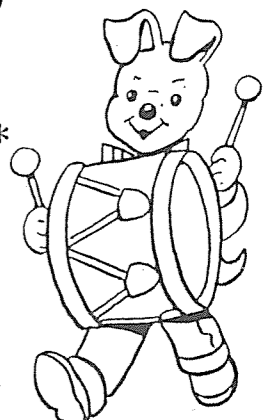
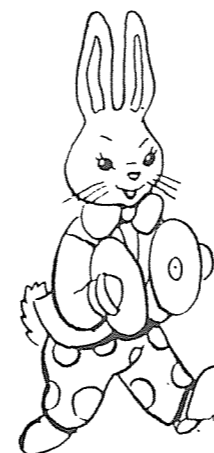

**N.C.N.A Membership                      Fully Insured**  
**For Details Contact : 6286507**



## Political Party Notes

faced by pupils and staff, due to the lack of space, failure to provide the much needed extension before the start of the 1994 school year will mean that the school will not be able to provide a transition year for those students who wish to avail of it.

We therefore call on the Minister to confirm the extension and give a definite date for building to begin.

### MAYNOOTH LABOUR NOTES

#### Maynooth Post Primary School

Minister of State at the Department of the Environment, Emmet Stagg T.D. has welcomed the sanctioning by the Minister for Education of the funding for repairs to the roof of Maynooth Post Primary School. The amount approved for the repairs required is £50,000 and the school has now been given the go ahead to have work carried out.

#### Traffic Flow Main Street

Councillor John McGinley has tabled the following motion for the next Celbridge Area Committee meeting.

"That the following steps be taken in order to improve traffic flow in the Main Street, Maynooth:-

- Put box junction and double yellow lines at the Roost and Dunboyne Road junctions.
- Put double yellow lines from Fuscuardis to Hula Bou.
- Put double yellow lines at Brady's Pub."

#### Greenfield Bollards

Contrary to the front page headlines in the Leinster Leader the procedure to have the bollards put in place has not met with any obstacles. As agreed with all the Councillors the Area Committee will decide on the bollards at its meeting on 29th Oct. and this decision will then go to the full Council in November, for approval.

#### Maynooth Development Plan

Work on the Leixlip Plan finished on 8th. Oct. after ten three hour meetings. Consideration of the Maynooth Plan will begin early November and hopefully should be completed before Christmas. The plan is then displayed for 3 months for public comment.

#### Mullen Bridge to Greenfield Road

Cllr. John McGinley has asked that the following work be carried out.

The gap in the wall to be repaired as a matter of urgency. Road repairs to be carried out at the entrance to Castlebridge Estate.

Re-surfacing to be carried out on the road at the entrance to Greenfields.

#### Straffan Road Realignment

Cllr. John McGinley has been advised that the realignment of the Straffan Road should commence in January 1994.

The "thing" will finally be knocked down and this would be an ideal opportunity for the people of Maynooth to have a victory party.

#### Dunboyne Road

Minister Stagg and Cllr. McGinley have made further representations to Kildare County Council requesting urgent repairs and re-surfacing on the Dunboyne Road at Mariaville.

#### Material Dumped at Laraghbryan Cemetery

Following complaints of material being dumped at the inside of the wall at Laraghbryan Cemetery, Minister Stagg contacted Kildare County Council.

The Council have confirmed that the local area engineer will have the material removed as a matter of urgency.

#### Ramps at Pound Lane

To date Kildare County Council have not agreed on the location of the three ramps along Pound Lane.

Minister Stagg and Cllr. McGinley have been in contact with the Council and have requested that the Council agree the location of the ramps with Lyreen Residents Association prior to them being put in place.

#### Cablelink Wires On Trees In Main Street

Arising from complaints from residents Minister Stagg has been in contact with Kildare County Council concerning the removal of Cablelink wires from the trees on Main Street.

The Council have advised that they will contact Cablelink to ensure that the cables are removed urgently.

#### Expanded Labour Advice Service

Minister Emmet Stagg continues to be available to the people of Maynooth every Saturday at 4.00p.m. in Caulfield's (private meeting room).

Cllr. John McGinley will be holding an Advice Service in Caulfield's (private meeting room) at 8.00p.m. every Thursday. If you require assistance of a community or private nature please feel free to call. Cllr. John McGinley will also be operating an Advice Service in Celbridge in Norris's back lounge at 7.00p.m. every Thursday.

## BIRTHDAYS

Aisling Folan, belated Happy Birthday (21st Oct.). Keep the faith. Love, Jon and gang, New Jersey. xxx

Carol Lysaght: Happy Birthday, 24th October, belatedly. Blame it on the love of rock 'n' roll. From Aisling, Chris & J.B.J.

A very happy eighth birthday to my friend, Katie Walsh. Love from Sarah. Sorry it's late, Kate!

Happy Birthday to Simon McGrath and Bernie Sperin who both celebrated birthdays on 13th November. Simon was 15 and Bernie was 17.

To Ciara Henry - Moses says he LOVES you!!!!

For Kathleen who will score twice (at least!) on November 3rd. From Primrose and Prawnface.

## Birthdays

Happy 12th Birthday, November 14th to Richard McGovern, Greenfield.

Best wishes from Nannie Una and Uncle Kevin, also from Michael, Eileen and girls.

*If something happens to you  
what happens to them?*

Happy 8th Birthday, November 27th to Debbie McGovern, Greenfield. Best wishes from Nannie Una and Uncle Kevin, also from Noel, Marie and boys.

Happy 8th Birthday, November 27th to Debbie McGovern, Greenfield. With love from Mammy, Daddy, sisters, also from Nannie Flynn and family in Kilcloone.

Daniel Burke, Newtown, age 3, October 7th. Best wishes from Mammie.

Tammie Makey, November 1st. Amy Carpenter Oct. 5th, American students, 4 Moyglare Village. Best wishes. Raymond, Noelle and family.

Orla McCree, Kilcock, celebrated her 21st Birthday October 8th. Party in Clock House, Maynooth. Best wishes Julia, William, Kevin and Rose.

Caroline Traynor, Greenfield, October 15th. Her brother Seamus November 4th. Best wishes Daddy, Mammie and Martin.

Mark Newton, Railpark, age 8 on Oct 4th. Love from Nanny and Grandad.

David McTernan, Highfield, Kilcock. Age 15 on October 19th. Best wishes from Mammie, Daddy, Brother, Sister, Grannies and Grandads.

Happy Birthday to Catherine Fay, 14 Leinster Cottages, Maynooth, who will celebrate her Birthday on November 1st. Love from husband Séan, daughters Edel and Susan.

A belated Happy Birthday to my nephew Daniel who celebrated his birthday on October 20th. Lots of Love from Sue, Kevin & Kirsty.

Happy Birthday to Daniel King who celebrated his birthday on October 20th. Lots of Love from Mammy, Daddy, James, Shirley & Andrew.

#### Recent Birthday

Happy Birthday to Edel Fay, 14 Leinster Cottages, Maynooth, who celebrated her 9th Birthday on October 15th. Love from Daddy, Mammy and sister Susan.

## Congratulations

Eamon and Ann Gallagher, Greenfield Drive. Birth of baby boy, brother for Stephen, Christopher, Eamon, Fionola and Catherine.

Owen and Emily Lennon, Kilmacredock, Maynooth. Birth of baby girl, Maeve. Best wishes from Grannie, Grandad and family.

Congratulations to Rev. Fr. Supple, P.P., who reached his 10th year as Parish Priest of Maynooth on the 15th September, 1993. Hope he will be with us for many more years to come.

#### BEST WISHES

To Mick Nolan, The Green, Maynooth, who has retired from Manor Mills, October 10th, after 25 years' service there. Many happy years in retirement Mick from your wife, family, Mill staff and your many friends in Maynooth and elsewhere.

## ACKNOWLEDGEMENTS

The wife and daughters of the late William Costigan, Kingsbry, Maynooth, would like to thank most sincerely all who sympathised with them in their recent sad loss, to everyone who visited the house, attended the removal, mass and funeral, all who sent mass cards, letters and floral tributes. Our sincere gratitude to our very good neighbours and friends without whose help and support we could not have gotten through this very sad and difficult time in our lives. A special word of thanks to Fr. Supple, Fr. Cogan and the local Gardai. As it would be impossible to thank everyone individually we hope this acknowledgement will be accepted by all as a token of our deep gratitude. The holy sacrifice of Mass will be offered for your intentions.

Mrs. Mary O'Reilly Crinstown, Maynooth wishes to thank all of those who sympathised and sent mass cards on the death of her mother, Mrs. Bridget King recently. A special word of thanks to the priests of the parish for their support. The Holy Sacrifice of Mass will be offered for their intentions.

Anne McGarry and her family would like to thank all those who sympathised with them on their recent bereavement - those who sent Mass cards, letters of sympathy and floral tributes, Father Cogan, Michael Best, Father Seamus Madigan, Father Micheál MacGréil and all those who called to the house and attended the removal and funeral Mass.

Thanks also to everyone who was so kind and supportive during Tommy's illness - Father Supple, Dr. Cowhey, Jimmy McCormack M.P.S.I. and the Drogheda Memorial Hospice team, all of whom gave so generously of their time.

A very special word of thanks to Tommy's wonderful neighbours and friends who couldn't do enough for us and who continue to be a huge source of comfort to us.

It would be impossible to thank everyone personally, so please accept this as a token of our appreciation. The Holy Sacrifice of Mass has been offered for your intentions.

## Acknowledgements

Nolan: The wife, daughters, son-in-law, grandson of the late Thomas Nolan, Hillview, Newtown, Maynooth wish to thank all who sympathised with them in their recent sad bereavement; those who attended the removal, Mass and funeral, those who sent Mass cards, floral tributes, seraphic cards, messages of sympathy, those who called personally.

Special word of thanks to our kind neighbours and friends without whose help we could not have coped, also Very Rev. Fr. B. Supple P.P., Rev. Fr. D. Cogan C.C., Rev. Fr. D. Boylan P.C. Dr. Mary Condon, Naas Ambulance crew, Maynooth Garda, Maynooth G.A.A. Club.

Trusting this will be accepted by all in grateful acknowledgement. The Holy Sacrifice of Mass will be offered for your intentions.

Newton: The wife and family of the late Billy Newton, Railpark, Maynooth, wish to thank most sincerely all the kind people who sympathised with them in their recent sad bereavement, those who attended the removal of the remains, Mass and funeral, those who sent Mass cards and floral tributes and those who called personally. A special thanks to the priests of the parish for their kind support and all our very kind neighbours and friends who were so helpful in our time of need, also the local Gardai. Trusting this will be accepted by all in grateful acknowledgement. The Holy Sacrifice of Mass will be offered for your intentions.

## SYMPATHIES

Wife, daughters, son-in-law, grandson, brothers, sisters, brothers-in-law, sisters-in-law, nieces, nephews, relatives and friends of the late Thomas Nolan, Hillview, Newtown, Maynooth.

Wife, sons, mother, father, brother, sisters, father-in-law, brothers-in-law, sisters-in-law, nieces, nephews, relatives and friends of the late William Newton, Rail Park, Maynooth.

Family and friends of the late Margaret (Peggy) Fitzsimons (née Dwyer) Woodlands, Maynooth, formerly Ballyhack, Co. Wexford.

Son, daughters, brother, sisters, daughter-in-law, sons-in-law, grandchildren, relatives and friends of the late Patrick Tracey, Greenfield, Maynooth.

Parents, sisters, aunts, uncles, cousins, relatives and friends of the late Donal O'Riordan, Well Road, Dangan, Summerhill, Co. Meath, formerly Cluain Aoibhinn, Maynooth.

Noel Cassidy, The Roost Inn, Maynooth, on the death of his mother in Barnacolla, Co. Leitrim.

## Classified Ads

**Domestic Help Available** for Celbridge/Maynooth/Clane area. Reasonable rates, own car. Good references available. Phone: 6273609

**Material Dumped at Laraghbryan Cemetery**  
Following complaints of material being dumped at the inside of the wall at Laraghbryan Cemetery. Minister Stagg contacted

**Electric Cooker** - 4 Plate, Grill and Oven with Timer. Jackson Hallmark. Sell for £50. Phone: 6285293

**Tiling Services**- Ceramic and mosaic floor and wall tiling. Kitchens, Bathrooms, Patios etc. Attractive range of tiles available. For free estimates contact Rey Canpolat, **INTER-TILING LTD.** Tel.6273702

**For Sale:** Circular Teak Table, four chairs, and matching sideboard - £130. Phone 6285262

### MAYNOOTH SECRETARIAL SERVICES

Maynooth Community Council  
Main Street, Maynooth.  
Phone: 628 5922

• word processing • typing • letters •  
• minutes • cvs •

**Service Confidential**

**Contact: 628 5922 - 10 a.m. -  
4 p.m. Mon. - Fri.**

### MAYNOOTH SECRETARIAL SERVICES

#### STUDENTS!

**We specialise in**  
• Theses • Essays • Reports •  
CVs •

**Contact: 628 5922 - 10a.m. - 4p.m.  
Mon - Fri**

## If something happens to you, what happens to them?

If you contract a serious illness, it isn't just you that suffers - your family's security does too. And what is more worrying still is the fact that a 35 year old male has a one in three chance of suffering a heart attack before retirement.

*Frightening, isn't it?*

*Regrettably it's true!*

Most people, however, do recover from serious illness though it often requires a change in lifestyle - reduced working hours, home help, nursing care, alterations to the home. Sometimes the greatest long term effect of a serious illness is on the financial well-being of the family. A Critical Illness Policy is the ideal protection.

It provides valuable protection against the diagnosis of serious illness including cancer, heart attack, stroke, open heart surgery, permanent disability, paralysis, major organ transplant, multiple sclerosis, kidney failure, the list goes on.

For a direct comparison between the companies offering such policies and independent advice on the policy that suits your needs contact



INDEPENDENT MORTGAGE SHOP  
**Regan**

INDEPENDENT  BROKERS

INVESTMENT • FINANCE • INSURANCE  
AUCTIONEERS • ESTATE AGENTS

MAIN STREET, MAYNOOTH, CO. KILDARE  
Tel. 01-6285377 Fax 01-6285516

*FRANK REGAN - A GOOD DEAL BETTER*